



Impact Tools

Impact sockets

An extensive range of impact sockets and accessories specifically designed for power tools such as the range of Luna air tools

- Manufactured in chrome molybdenum in accordance with GGG-W-6608 to ensure the highest quality of materials
- Available in 1/4", 3/8", 1/2", 3/4" and 1" drive covering all the popular metric and AF sizes from 6mm to 95mm and 7/16" to 1 1/2" AF with regular, deep and thinwall options
- Full range of accessories including extension bars, adaptors and universal joints
- Available individually and in sets in DIN standard or ANSI standard to suit industrial and automotive applications
- Individually branded and size marked for quick identification
- 1/2", 3/4" and 1" ranges include a retaining pin and ring facility for added safety when used with power tools
- A full range of impact screwdriver bits and bit holders also available



Impact Socket Sets

Set containing 8 metric 3/8" drive 6 point impact sockets. Supplied on a clip rail.



9381	8 piece 3/8" drive regular metric impact socket set				
Regular impact sockets	3/8" drive	6 point	8, 10, 11, 13, 14, 16, 17, 19mm		



Stock No	PRICE
9381	€31.60

Set containing 8 metric deep 3/8" drive 6 point impact sockets. Supplied on a clip rail.



9386	8 piece 3/8" drive deep metric impact socket set				
Deep impact sockets	3/8" drive	6 point	8, 10, 11, 13, 14, 16, 17, 19mm		



Stock No	PRICE
9386	€42.00

24 piece set containing 1/4" drive regular and 3/8" drive regular and deep impact sockets plus an adaptor. Supplied in the Teng Tools TC tray with removable lid.



TT9024	24 piece 1/4" and 3/8" impact socket set (265x142x50mm, 1.07 kilos)				
Accessories	3/8" drive	3/8" Fx 1/4" M adaptor			
Regular impact sockets	1/4" drive	6 point	6, 7, 8, 10, 13mm		
Regular impact sockets	3/8" drive	6 point	8, 10, 11, 12, 13, 14, 16, 17, 19mm		
Deep impact sockets	3/8" drive	6 point	8, 10, 11, 12, 13, 14, 16, 17, 19mm		



Stock No	PRICE
TT9024	€83.30

Set containing 10 regular metric 1/2" drive 6 point impact sockets. Supplied on a clip rail. ANSI standard sockets suitable for automotive use.



9121	10 piece 1/2" drive regular metric impact socket set				
Regular impact sockets	1/2" drive	6 point	10, 11, 12, 13, 14, 17, 19, 21, 22, 24mm		



Stock No	PRICE
9121	€54.00



Impact Socket Sets

Set containing 10 deep metric $\frac{1}{2}$ " drive 6 point impact sockets. Supplied on a clip rail. ANSI standard sockets suitable for automotive use.

9126	10 piece $\frac{1}{2}$ " drive deep metric impact socket set				
Deep impact sockets	$\frac{1}{2}$ " drive	6 point	10, 11, 12, 13, 14, 17, 19, 21, 22, 24mm		



Stock No	PRICE
9126	€75.00

TENGTTOOLS

Set containing 16 $\frac{1}{2}$ " drive impact sockets, regular and deep. ANSI Standard suitable for automotive use. Supplied in the Teng Tools TC tray with removable lid.

TT9116	16 piece $\frac{1}{2}$ " drive regular and deep impact socket set (265x142x50mm, 2.2 kilos)				
Regular impact sockets	$\frac{1}{2}$ " drive	6 point	13, 15, 16, 17, 18, 19, 22, 24mm		
Deep impact sockets	$\frac{1}{2}$ " drive	6 point	13, 15, 16, 17, 18, 19, 22, 24mm		



Stock No	PRICE
TT9116	€99.50

TENGTTOOLS

$\frac{1}{2}$ " drive impact socket accessory set containing extension bars, universal joint and adaptors. DIN standard (TT9207) for industrial use with retaining pins and rings. TT9207A ANSI standard. Supplied in the Teng Tools TC tray with removable lid.

TT9207	7 piece $\frac{1}{2}$ " impact accessories set (265x142x50mm, 1.05 kilos)				
Adaptors			$\frac{3}{8}$ "Fx $\frac{1}{2}$ "M, $\frac{1}{2}$ "Fx $\frac{3}{4}$ "M, $\frac{1}{2}$ "Fx $\frac{3}{8}$ "M		
Extension Bars	$\frac{1}{2}$ " drive	3", 5" and 10"			
Universal Joint	$\frac{1}{2}$ " drive				



Stock No	PRICE
TT9207	€83.00
TT9207A	€81.00

TENGTTOOLS

Set containing 20 $\frac{1}{2}$ " drive impact sockets, regular and deep plus locking pins and O-Rings. DIN Standard suitable for industrial use with retaining rings and pins. Supplied in the Teng Tools TC tray with removable lid.

TT9120D	20 piece $\frac{1}{2}$ " drive regular and deep impact socket set (265x142x50mm, 3.2 kilos)				
Regular impact sockets	$\frac{1}{2}$ " drive	6 point	13, 15, 16, 17, 18, 19, 22, 24mm		
Deep impact sockets	$\frac{1}{2}$ " drive	6 point	13, 15, 16, 17, 18, 19, 22, 24mm		
Locking pins			20x3.5mm, 25x3.5mm		
O-Rings			3x20mm, 3x24mm		



Stock No	PRICE
TT9120D	€132.00

TENGTTOOLS

Set containing 12 $\frac{1}{2}$ " drive TX impact sockets. For use with retaining pins and rings. Supplied in the Teng Tools TC tray with removable lid.

TT9212TX	12 piece $\frac{1}{2}$ " drive TX bit impact socket set (265x142x50mm, 1.36 kilos)				
TX impact sockets	$\frac{1}{2}$ " drive	TX	10, 15, 20, 25, 27, 30, 35, 40, 45, 50, 55, 60, 70		



Stock No	PRICE
TT9212TX	€136.00

TENGTTOOLS



Impact Tools

Impact tools

15 piece 3/8" and 1/2" drive hex impact socket bit set. Supplied in the Teng Tools TC tray with removable lid.



TT9015HX	15 piece hex impact socket bit set (265x142x50mm, 1.49 kilos)
Hex impact socket bits	3/8" drive 4, 5, 6, 7, 8, 10, 12mm
Hex impact socket bits	1/2" drive 5, 6, 8, 10, 12, 14, 17mm



Stock No	PRICE
TT9015HX	€145.50

3/4" drive impact socket set containing regular sockets 19 to 38mm, plus accessories including extension bar and retaining rings and pins.



TTD9416	16 piece 3/4" drive impact socket set (265x284x50mm, 5.6kilos)
Accessories	3/4" drive 7" impact extension bar, 3 retaining rings, 3 retaining pins
Regular impact sockets	3/4" drive 6 point 19 (3/4"), 24, 27 (1 1/8"), 30 (1 1/4"), 32, 33, 34, 36, 38mm



Stock No	PRICE
TTD9416	€149.90

15 piece set containing 15 metric regular and deep impact sockets to DIN standard. Supplied in the Teng Tools TTX storage tray.

TTX9415	15 piece 3/4" drive regular/deep impact socket set (560x110x60mm, 9.0 kilos)
Regular impact sockets	3/4" drive 6 point 19, 24, 27, 28, 30, 32, 34, 36mm
Deep impact sockets	3/4" drive 6 point 19 (3/4"), 24, 27 (1 1/8"), 30 (1 1/4"), 32, 33, 36mm



Stock No	PRICE
TTX9415	€250.00

Impact Driver sets

Reversible action. Driver designed with 1/2" square drive, but also equipped with a chuck in which bits with 5/16" hex can be fitted. Supplied complete with chuck and four screwdriver bits for slotted heads and Phillips heads. Supplied in metal case.



ID506	6 piece 1/2" drive industrial impact driver (195x66x45mm, 0.95 kilos)
Accessories	1/2" drive Industrial quality reversible impact driver, impact coupler adaptor
Impact bits	5/16" hex 8x36mm flat, 10x36mm flat, PH2, PH3



Stock No	PRICE
ID506	€35.60



Impact driver bits

Bit set for impact driver set ID506.

ID506BIT	4 piece industrial impact driver bit set
Impact bits	5/16" hex 8x36mm flat, 10x36mm flat, PH2, PH3

Stock No	PRICE
ID506BIT	€5.80

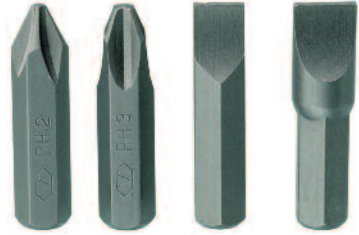

Impact Driver Sets

Reversible action. Driver designed with 1/2" square drive, but also equipped with a chuck in which bits with 5/16" hex can be fitted. Supplied complete with 12 screwdriver bits for slotted heads, Phillips heads and internal hex screw heads. Supplied in a handy storage case.

ID51515 piece 1/2" drive heavy duty impact driver set (223x115x52mm, 1.0 kilos)	
Accessories	1/2" drive Heavy duty reversible impact driver, impact coupler adaptor, 5/16" hex x 3/8" M adaptor
Impact bits	5/16" hex 6x36mm flat, 8x36mm flat, 10x36mm flat, 12x36mm flat, PH1, PH2, PH3, PH4, 4mm hex, 5mm hex, 6mm hex, 8mm hex

Stock No	PRICE
ID515	€33.50



Bit set for impact driver set ID515.

ID515BIT	13 piece impact driver bit set
Impact bits	5/16" hex 6x36mm flat, 8x36mm flat, 10x36mm flat, 12x36mm flat, PH1, PH2, PH3, PH4, 4mm hex, 5mm hex, 6mm hex, 8mm hex, adaptor 5/16" hex:3/8" drive

Stock No	PRICE
ID515BIT	€12.80



Impact Bits

Impact bits 1/4" hex for use with 3/8" drive impact driver

Stock No.	Drive	Description	Length mm	Price
210603	1/4" hex	3mm hex impact bit	40.0	€3.00
210604	1/4" hex	4mm hex impact bit	40.0	€3.00
210605	1/4" hex	5mm hex impact bit	40.0	€3.00
210605	1/4" hex	5mm hex impact bit	40.0	€3.00
210606	1/4" hex	6mm hex impact bit	40.0	€3.00
210608	1/4" hex	8mm hex impact bit	40.0	€3.00
240104	1/4" hex	4mm flat impact bit	40.0	€3.00
240106	1/4" hex	6mm flat impact bit	40.0	€3.00
240108	1/4" hex	8mm flat impact bit	40.0	€3.00
230101	1/4" hex	PH1 impact bit	40.0	€3.00
230102	1/4" hex	PH2 impact bit	40.0	€3.00
220110	1/4" hex	TX10 impact bit	40.0	€3.00
220115	1/4" hex	TX15 impact bit	40.0	€3.00
220120	1/4" hex	TX20 impact bit	40.0	€3.00
220125	1/4" hex	TX25 impact bit	40.0	€3.00
220130	1/4" hex	TX30 impact bit	40.0	€3.00
220140	1/4" hex	TX40 impact bit	40.0	€3.00





Impact Tools

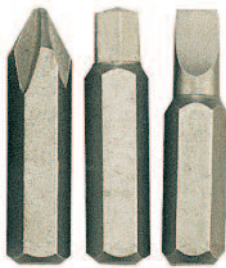

Impact bits $\frac{5}{16}$ " hex for use with $\frac{1}{2}$ " drive impact drivers.

TENGOOLS

Stock No.	Drive	Description	Length mm	Price
910504	$\frac{5}{16}$ " hex	4mm hex impact bit	36.0	€4.40
910505	$\frac{5}{16}$ " hex	5mm hex impact bit	36.0	€4.40
910506	$\frac{5}{16}$ " hex	6mm hex impact bit	36.0	€4.40
910508	$\frac{5}{16}$ " hex	8mm hex impact bit	36.0	€4.40
910510	$\frac{5}{16}$ " hex	10mm hex impact bit	36.0	€4.40
920001	$\frac{5}{16}$ " hex	PZ1 impact bit	36.0	€4.40
920002	$\frac{5}{16}$ " hex	PZ2 impact bit	36.0	€4.40
920003	$\frac{5}{16}$ " hex	PZ3 impact bit	36.0	€4.40
940008	$\frac{5}{16}$ " hex	8mm flat impact bit	36.0	€4.40
940006	$\frac{5}{16}$ " hex	6mm flat impact bit	36.0	€4.40
940010	$\frac{5}{16}$ " hex	10mm flat impact bit	36.0	€4.40
940012	$\frac{5}{16}$ " hex	12mm flat impact bit	36.0	€4.40
930001	$\frac{5}{16}$ " hex	PH1 impact bit	36.0	€4.40
930002	$\frac{5}{16}$ " hex	PH2 impact bit	36.0	€4.40
930003	$\frac{5}{16}$ " hex	PH3 impact bit	36.0	€4.40
930004	$\frac{5}{16}$ " hex	PH4 impact bit	36.0	€4.40
970030	$\frac{5}{16}$ " hex	TX30 impact bit	36.0	€4.40
970040	$\frac{5}{16}$ " hex	TX40 impact bit	36.0	€4.40
970045	$\frac{5}{16}$ " hex	TX45 impact bit	36.0	€4.40
970050	$\frac{5}{16}$ " hex	TX50 impact bit	36.0	€4.40
970055	$\frac{5}{16}$ " hex	TX55 impact bit	36.0	€4.40

TENGOOLS

Impact Accessories

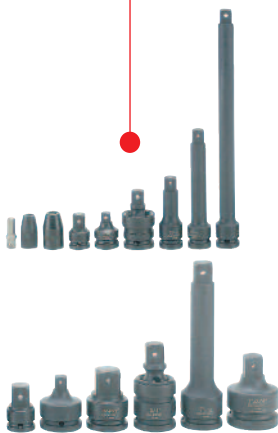

Stock No.	Drive	Description	Retaining ring	Retaining pin	Price
980035-C	$\frac{3}{8}$ "	$\frac{3}{8}$ "F: $\frac{1}{4}$ "M adaptor	-	-	€8.90
980036-C	$\frac{3}{8}$ "	$\frac{3}{8}$ "F: $\frac{1}{2}$ "M adaptor. DIN standard	-	-	€10.90
980060-C	$\frac{3}{8}$ "	Coupler adaptor for $\frac{1}{4}$ " hex	-	-	€7.10
980086	$\frac{3}{8}$ "	$\frac{3}{8}$ "F: $\frac{5}{16}$ " Hex	-	-	€7.50

Stock No.	Drive	Description	Retaining ring	Retaining pin	Price
920020-C	$\frac{1}{2}$ "	3" impact extension bar. DIN standard	-	-	€13.00
920020-C	$\frac{1}{2}$ "	3" impact extension bar. DIN standard	0935202	P90320	€12.50
920020A-C	$\frac{1}{2}$ "	3" impact extension bar. ANSI standard	-	-	€11.90
920021-C	$\frac{1}{2}$ "	5" impact extension bar. DIN standard	0935202	P90320	€14.70
920021A-C	$\frac{1}{2}$ "	5" impact extension bar. ANSI standard	-	-	€13.90
920023-C	$\frac{1}{2}$ "	10" impact extension bar. DIN standard	0935202	P90320	€20.80
920023A-C	$\frac{1}{2}$ "	10" impact extension bar. ANSI standard	-	-	€19.90
920030-C	$\frac{1}{2}$ "	impact universal joint. DIN standard	-	-	€22.00
920030A-C	$\frac{1}{2}$ "	impact universal joint. ANSI standard	-	-	€21.50
920036-C	$\frac{1}{2}$ "	impact $\frac{1}{2}$ "F: $\frac{3}{8}$ "M adaptor. DIN standard	0935202	P90320	€11.60
920036A-C	$\frac{1}{2}$ "	impact $\frac{1}{2}$ "F: $\frac{3}{8}$ "M adaptor. ANSI standard	-	-	€11.20
920037-C	$\frac{1}{2}$ "	impact $\frac{1}{2}$ "F: $\frac{3}{4}$ "M adaptor. DIN standard	0935202	P90320	€18.40
920037A-C	$\frac{1}{2}$ "	impact $\frac{1}{2}$ "F: $\frac{3}{4}$ "M impact adaptor. ANSI standard.	-	-	€18.40
920060-C	$\frac{1}{2}$ "	coupler adaptor for $\frac{3}{8}$ " hex	-	-	€7.90

Stock No.	Drive	Description	Retaining ring	Retaining pin	Price
940022-C	$\frac{3}{4}$ "	7" impact extension bar	093538	P90437	€40.00
940030-C	$\frac{3}{4}$ "	impact universal joint	093538	P90437	€58.50
940037-C	$\frac{3}{4}$ "	impact $\frac{3}{4}$ "F: $\frac{1}{2}$ "M adaptor	093538	P90437	€36.30
940085-C	$\frac{3}{4}$ "	impact $\frac{3}{4}$ "F: 1" M adaptor	093538	P90437	€23.30

Stock No.	Drive	Description	Retaining ring	Retaining pin	Price
910086	1"	impact 1"F: $\frac{3}{4}$ "M adaptor	093546	P90543	€39.90



Retaining Rings and Pins

Retaining rings and pins for use with DIN standard impact sockets and accessories.

Stock No.	Description	Price
092416	Retaining ring 16.0x2.4mm	€2.00
092419	Retaining ring 19.0x2.4mm	€2.00
0935202	Retaining ring 20.0x3.5mm	€2.00
093525	Retaining ring 25.0x3.5mm	€2.00
093528	Retaining ring 28.0x3.5mm	€2.00
093530	Retaining ring 30.0x3.5mm	€2.00
093532	Retaining ring 32.0x3.5mm	€2.00
093534	Retaining ring 34.0x3.5mm	€2.00
093538	Retaining ring 38.0x3.5mm	€2.30
093546	Retaining ring 46.0x3.5mm	€2.60
093548	Retaining ring 48.0x3.5mm	€2.60
095775	Retaining ring 75.0x5.7mm	€2.90
P902515	Retaining pin 2.5x15mm	€2.00
P902518	Retaining pin 2.5x18mm	€2.00
P90320	Retaining pin 3x20mm	€2.00
P90324	Retaining pin 3x24mm	€2.00
P90328	Retaining pin 3x28mm	€2.00
P90332	Retaining pin 3x32mm	€2.00
P90437	Retaining pin 3x37mm	€2.00
P90543	Retaining pin 3x43mm	€2.90
P90675	Retaining ring 6x75mm	€3.20

TENGOOLS



1/4" Drive Impact Sockets

1/4" drive impact sockets regular 6 point metric. Chrome molybdenum.

Stock No.	Size	L	T	D1	D2	Weight	Price
960506-C	6	21.2	10.0	9.5	12.0	20	€4.40
960507-C	7	21.2	11.0	11.0	12.0	20	€4.40
960508-C	8	21.2	11.0	12.0	12.0	20	€4.40
960510-C	10	21.2	12.5	14.0	14.0	30	€4.40
960513-C	13	21.2	12.0	18.0	18.0	30	€4.40

TENGOOLS

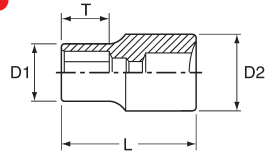

3/8" Drive Impact Sockets

3/8" drive impact sockets regular 6 point metric. Chrome molybdenum.

Stock No.	Size	L	T	D1	D2	Weight	Price
980508-C	8	30.0	9.5	12.6	19.0	33	€5.10
980510-C	10	30.0	9.5	15.1	19.0	34	€5.10
980511-C	11	30.0	10.0	17.0	19.0	37	€5.10
980512-C	12	30.0	10.0	19.0	19.0	40	€5.10
980513-C	13	30.0	10.0	19.0	19.0	41	€5.10
980514-C	14	30.0	10.0	20.0	20.0	41	€5.10
980516-C	16	30.0	11.0	24.0	24.0	64	€5.10
980517-C	17	30.0	11.0	24.0	24.0	64	€5.10
980519-C	19	30.0	11.0	26.0	26.0	72	€5.10

TENGOOLS

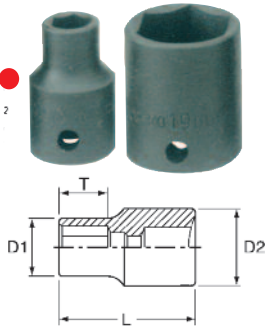

3/8" drive impact sockets deep 6 point metric. Chrome molybdenum.

Stock No.	Size	L	T	D1	D2	Weight	Price
980608-C	8	65.0	12.8	12.6	19.0	95	€7.00
980610-C	10	65.0	26.0	15.2	19.0	89	€7.00
980611-C	11	65.0	27.0	17.0	19.0	87	€7.00
980612-C	12	65.0	27.0	19.0	19.0	85	€7.00
980613-C	13	65.0	27.0	19.0	19.0	80	€7.00
980614-C	14	65.0	27.0	20.0	20.0	87	€7.00
980616-C	16	65.0	27.0	24.0	24.0	144	€7.70
980617-C	17	65.0	27.0	24.0	24.0	130	€7.70
980619-C	19	65.0	27.0	26.0	26.0	143	€8.30

TENGOOLS

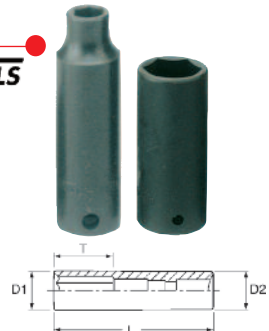



Impact Tools

1/2" Drive Impact Sockets

1/2" drive impact sockets regular 6 point metric. Chrome molybdenum DIN standard for industrial use.



Stock No.	Size mm	L mm	T mm	D1 mm	D2 mm	Weight g	Retaining Ring	Retaining Pin	Price
920508-C	8	38.0	9.0	15.0	22.0	90	0935202	P90320	€6.10
920510-C	10	38.0	12.0	17.0	22.0	90	0935202	P90320	€6.10
920511-C	11	38.0	12.0	18.0	22.0	90	0935202	P90320	€6.10
920512-C	12	38.0	12.0	19.0	22.0	90	0935202	P90320	€6.10
920513-C	13	38.0	12.0	20.0	24.0	90	0935202	P90320	€6.10
920514-C	14	38.0	12.0	24.0	24.0	90	0935202	P90320	€6.10
920515-C	15	38.0	12.0	25.0	25.0	130	093525	P90324	€6.10
920516-C	16	38.0	12.0	25.0	25.0	130	093525	P90324	€6.40
920517-C	17	38.0	12.0	25.0	26.0	130	093525	P90324	€6.60
920518-C	18	38.0	13.0	26.0	26.0	130	093525	P90324	€6.80
920519-C	19	38.0	13.0	28.0	28.0	130	093525	P90324	€7.10
920520-C	20	38.0	13.0	30.0	30.0	130	093525	P90324	€7.20
920521-C	21	38.0	13.0	30.0	30.0	130	093525	P90324	€7.20
920522-C	22	38.0	13.0	32.0	32.0	130	093525	P90324	€7.30
920523-C	23	38.0	13.0	32.0	32.0	130	093525	P90324	€8.00
920524-C	24	45.0	19.0	34.0	34.0	150	093525	P90324	€8.60
920525-C	25	45.0	20.0	36.0	36.0	160	093525	P90324	€9.10
920526-C	26	50.0	20.0	36.0	36.0	165	093525	P90324	€10.20
920527-C	27	50.0	20.0	38.0	38.0	195	093525	P90324	€10.40
920528-C	28	50.0	20.0	40.0	38.0	195	093525	P90324	€10.60
920529-C	29	50.0	20.0	40.0	38.0	185	093525	P90324	€10.70
920530-C	30	50.0	20.0	42.0	38.0	250	093525	P90324	€10.90
920532-C	32	50.0	20.0	44.0	38.0	300	093525	P90324	€11.30

1/2" drive impact sockets regular 6 point metric. ANSI standard suitable for automotive use. Chrome molybdenum.

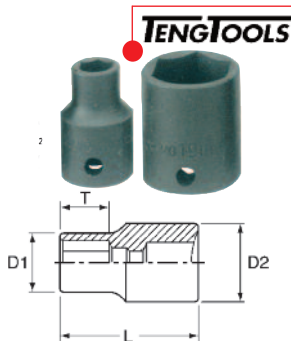

Stock No.	Size mm	L mm	T mm	D1 mm	D2 mm	Weight g	Price
920513A	13	38.0	12.0	20.0	24.0	90	€5.30
920515A	15	38.0	12.0	25.0	25.0	130	€5.50
920516A	16	38.0	12.0	25.0	25.0	130	€5.80
920517A	17	38.0	12.0	25.0	26.0	130	€5.90
920518A	18	38.0	13.0	26.0	26.0	130	€6.10
920519A	19	38.0	13.0	28.0	28.0	130	€6.20
920522A	22	38.0	13.0	32.0	32.0	130	€6.50
920524A	24	45.0	19.0	34.0	34.0	150	€8.00

1/2" drive impact sockets regular 6 point AF. Chrome molybdenum. DIN standard for industrial use.

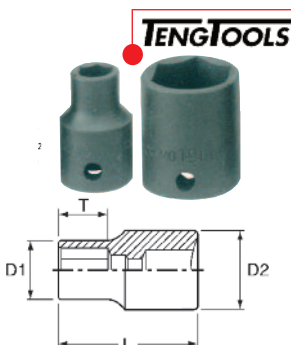

Stock No.	Size AF	L mm	T mm	D1 mm	D2 mm	Weight g	Retaining Ring	Retaining Pin	Price
920114-C	7/16"	38.0	12.0	18.0	22.0	70	0935202	P90320	€6.10
920116-C	1/2"	38.0	12.0	20.0	22.0	70	0935202	P90320	€6.10
920118-C	9/16"	38.0	12.0	22.0	24.0	70	0935202	P90320	€6.10
920120-C	5/8"	38.0	12.0	25.0	25.0	80	0935202	P90320	€6.10
920122-C	11/16"	38.0	13.0	26.0	26.0	90	0935202	P90320	€6.80
920124-C	3/4"	38.0	13.0	28.0	28.0	110	0935202	P90320	€7.10
920126-C	7/8"	38.0	13.0	30.0	30.0	120	0935202	P90320	€7.10
920128-C	15/16"	38.0	13.0	32.0	32.0	140	0935202	P90320	€7.10
920130-C	1"	38.0	13.0	34.0	34.0	160	093530	P90328	€8.20
920132-C	1"	38.0	14.0	36.0	36.0	180	093532	P90328	€8.20



1/2" Drive Impact Sockets

1/2" drive impact sockets deep 6 point metric. Chrome molybdenum. DIN standard suitable for industrial use.

Stock No.	Size mm	L mm	T mm	D1 mm	D2 mm	Weight g	Retaining Ring	Retaining Pin	Price
920610-C	10	78.0	14.0	17.5	25.0	180	0935202	P90320	€11.30
920611-C	11	78.0	14.0	18.7	25.0	180	0935202	P90320	€11.30
920612-C	12	78.0	14.0	20.0	25.0	180	0935202	P90320	€11.30
920613-C	13	78.0	14.0	21.0	25.0	180	0935202	P90320	€11.30
920614-C	14	78.0	17.0	22.5	25.0	180	0935202	P90320	€11.30
920615-C	15	78.0	17.0	23.7	30.0	210	093525	P90324	€11.30
920616-C	16	78.0	17.0	25.0	30.0	210	093525	P90324	€11.30
920617-C	17	78.0	17.0	26.0	30.0	240	093525	P90324	€11.30
920618-C	18	78.0	17.0	27.5	30.0	260	093525	P90324	€11.30
920619-C	19	78.0	17.0	28.7	30.0	260	093525	P90324	€11.30
920621-C	21	78.0	19.0	30.0	30.0	260	093525	P90324	€11.60
920622-C	22	78.0	24.0	32.0	30.0	240	093525	P90324	€12.20
920624-C	24	78.0	24.0	35.0	30.0	270	093525	P90324	€13.20
920627-C	27	78.0	24.0	38.7	30.0	400	093525	P90324	€16.50
920628-C	28	78.0	23.0	40.0	30.0	400	093525	P90324	€16.50
920629-C	29	78.0	26.0	40.0	30.0	400	093525	P90324	€16.50
920630-C	30	78.0	25.0	42.0	30.0	400	093525	P90324	€16.90
920632-C	32	78.0	25.0	44.0	30.0	500	093525	P90324	€17.20
920635-C	35	78.0	57.0	47.0	30.0	500	093525	P90324	€17.30
920636-C	36	78.0	25.0	49.0	30.0	500	093525	P90324	€21.90

TENGOOLS



1/2" drive impact sockets deep 6 point metric.

ANSI standard suitable for automotive use. Chrome molybdenum.

Stock No.	Size mm	L mm	T mm	D1 mm	D2 mm	Weight g	Price
920613A	13	78.0	14.0	21.0	25.0	180	€10.50
920615A	15	78.0	17.0	23.7	30.0	210	€10.50
920616A	16	78.0	17.0	25.0	30.0	210	€10.60
920617A	17	78.0	17.0	26.0	30.0	240	€10.80
920618A	18	78.0	17.0	27.5	30.0	260	€10.80
920619A	19	78.0	17.0	28.7	30.0	260	€10.80
920622A	22	78.0	24.0	32.0	30.0	240	€11.20
920624A	24	78.0	24.0	35.0	30.0	270	€12.10

TENGOOLS

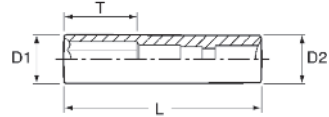

1/2" drive impact sockets deep 6 point AF. Chrome Molybdenum.

DIN standard for industrial use.

Stock No.	Size AF	L mm	T mm	D1 mm	D2 mm	Weight g	Retaining Ring	Retaining Pin	Price
920214-C	7/16"	78.0	14.0	18.0	22.0	140	0935202	P90320	€10.80
920216-C	1/2"	78.0	14.0	20.0	22.0	140	0935202	P90320	€10.80
920218-C	9/16"	78.0	17.0	22.0	24.0	170	0935202	P90320	€11.10
920220-C	5/8"	78.0	17.0	24.0	24.0	170	0935202	P90320	€11.50
920222-C	11/16"	78.0	17.0	26.0	26.0	180	0935202	P90320	€12.00
920224-C	3/4"	78.0	19.0	28.0	28.0	220	0935202	P90320	€12.30
920226-C	5/8"	78.0	24.0	30.0	30.0	230	0935202	P90320	€12.30
920228-C	7/8"	78.0	24.0	32.0	32.0	280	0935202	P90320	€13.00
920230-C	15/16"	78.0	24.0	34.0	34.0	310	093530	P90328	€13.00
920232-C	1"	78.0	24.0	36.0	36.0	350	093532	P90328	€14.30
920242-C	1 5/16"	78.0	54.0	45.0	38.0	500	093534	P90332	€18.20
920248-C	1 1/2"	78.0	54.0	52.5	38.0	500	093534	P90332	€26.00

TENGOOLS

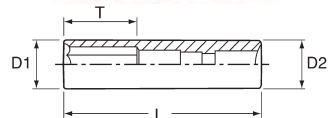



Impact Tools

1/2" Drive Impact Sockets

1/2" drive TX impact sockets regular. Chrome molybdenum.



TENGTTOOLS

Stock No.	Size mm	L mm	D1 mm	D2 mm	Weight g	Retaining Ring	Retaining Pin	Price
921210TX-C	10	78.0	6.5	25.0	90	0935202	P90320	€14.30
921215TX-C	15	78.0	6.5	25.0	90	0935202	P90320	€14.30
921220TX-C	20	78.0	6.5	25.0	90	0935202	P90320	€14.30
921225TX-C	25	78.0	6.5	25.0	90	0935202	P90320	€14.30
921227TX-C	27	78.0	6.5	25.0	90	0935202	P90320	€14.30
921230TX-C	30	78.0	6.5	25.0	130	093525	P90324	€14.30
921240TX-C	40	78.0	8.0	25.0	130	093525	P90324	€14.30
921245TX-C	45	78.0	9.0	25.0	130	093525	P90324	€14.30
921250TX-C	50	78.0	10.0	25.0	130	093525	P90324	€14.30
921255TX-C	55	78.0	12.0	25.0	130	093525	P90324	€14.30
921260TX-C	60	78.0	14.0	25.0	130	093525	P90324	€14.30
921270TX-C	70	78.0	16.0	25.0	130	093525	P90324	€14.30

3/4" Drive Impact Sockets

3/4" drive impact sockets regular 6 point metric, with locking pin and retaining ring facility. Chrome molybdenum. DIN Standard for industrial use.

TENGTTOOLS

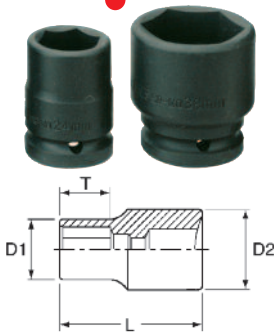

Stock No.	Size mm	L mm	T mm	D1 mm	D2 mm	Weight g	Retaining Ring	Retaining Pin	Price
940519-C	19	50.0	17.0	36.0	38.0	247	093538	P90437	€14.00
940521-C	21	50.0	17.0	36.0	38.0	250	093538	P90437	€14.00
940522-C	22	52.0	17.0	36.0	38.0	252	093538	P90437	€14.00
940523-C	24	52.0	17.0	36.0	38.0	255	093538	P90437	€14.00
940524-C	27	52.0	17.0	40.0	38.0	270	093538	P90437	€14.00
940527-C	28	52.0	23.0	44.0	44.0	300	093538	P90437	€14.00
940530-C	30	52.0	23.0	44.0	44.0	330	093538	P90437	€17.30
940532-C	32	52.0	23.0	44.0	44.0	330	093538	P90437	€18.70
940533-C	33	56.0	23.0	47.0	44.0	395	093538	P90437	€19.30
940534-C	34	56.0	23.0	48.0	44.0	420	093538	P90437	€21.00
940536-C	36	56.0	25.0	51.0	44.0	455	093538	P90437	€22.60
940538-C	38	56.0	25.0	53.0	44.0	465	093538	P90437	€23.40
940541-C	41	58.0	26.0	60.0	44.0	610	093538	P90437	€24.30
940546-C	46	63.0	30.0	67.0	44.0	775	093538	P90437	€27.90

3/4" drive impact sockets regular 6 point AF with locking pin and retaining ring facility. Chrome molybdenum. DIN Standard for industrial use.

TENGTTOOLS

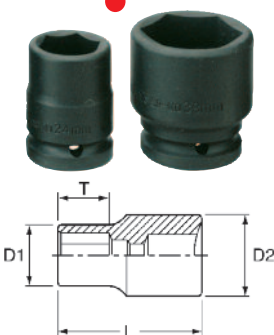

Stock No.	Size AF	L mm	T mm	D1 mm	D2 mm	Weight g	Retaining Ring	Retaining Pin	Price
940132-C	1"	50.0	17.0	36.0	38.0	247	093538	P90437	€14.20
940134-C	1 1/16"	52.0	17.0	36.0	38.0	255	093538	P90437	€14.40
940140-C	1 1/4"	52.0	17.0	40.0	38.0	270	093538	P90437	€15.50
940142-C	1 3/8"	52.0	23.0	44.0	44.0	300	093538	P90437	€19.80
940144-C	1 3/8"	52.0	22.0	44.0	44.0	165	093538	P90437	€21.10
940146-C	1 7/16"	52.0	23.0	44.0	44.0	330	093538	P90437	€22.00
940148-C	1 1/2"	56.0	23.0	47.0	44.0	395	093538	P90437	€23.50



3/4" Drive Impact Sockets

3/4" drive impact sockets deep 6 point metric with locking pin and retaining ring facility. Chrome molybdenum. DIN Standard for industrial use.

Stock No.	Size mm	L mm	T mm	D1 mm	D2 mm	Weight g	Retaining Ring	Retaining Pin	Price
940619-C	19	95.0	23.0	33.0	44.0	595	093538	P90437	€24.50
940621-C	21	95.0	23.0	35.0	44.0	610	093538	P90437	€24.50
940622-C	22	95.0	23.0	37.0	44.0	620	093538	P90437	€24.50
940623-C	23	95.0	23.0	38.0	44.0	630	093538	P90437	€24.50
940624-C	24	95.0	51.0	39.0	44.0	640	093538	P90437	€24.50
940627-C	27	95.0	62.0	43.0	44.0	680	093538	P90437	€24.50
940630-C	30	95.0	65.0	47.0	44.0	720	093538	P90437	€24.50
940632-C	32	95.0	27.0	49.0	44.0	870	093538	P90437	€24.50
940633-C	33	95.0	28.0	51.0	44.0	860	093538	P90437	€25.70
940634-C	34	95.0	62.0	52.0	44.0	810	093538	P90437	€27.20
940636-C	36	95.0	64.0	54.0	44.0	830	093538	P90437	€27.20
940638-C	38	95.0	63.0	57.0	44.0	920	093538	P90437	€29.40
940641-C	41	95.0	54.0	58.0	44.0	790	093538	P90437	€42.50
940646-C	46	95.0	58.0	67.0	44.0	900	093538	P90437	€50.00

TENGTOLS

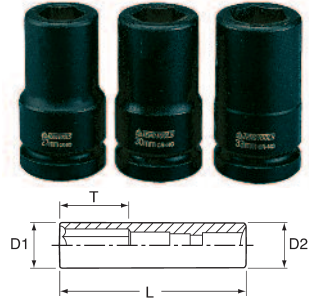

1" Drive Impact Sockets

1" drive impact sockets regular, metric with locking pin and retaining ring facility. DIN standard for industrial use.

Stock No.	Size mm	L mm	T mm	D1 mm	D2 mm	Weight g	Retaining Ring	Retaining Pin	Price
910524	24	58.0	18.0	41.0	54.0	640	093546	P90543	€26.50
910527	27	58.0	20.0	46.0	54.0	645	093546	P90543	€26.50
910530	30	60.0	21.0	49.0	54.0	680	093546	P90543	€26.50
910532	32	60.0	21.0	52.0	54.0	700	093546	P90543	€26.50
910533	33	60.0	21.0	53.0	54.0	700	093546	P90543	€26.50
910534	34	60.0	21.0	55.0	54.0	690	093546	P90543	€26.50
910536	36	65.0	30.0	56.0	54.0	700	093546	P90543	€26.50
910538	38	65.0	30.0	59.0	54.0	750	093546	P90543	€27.80
910541	41	67.0	30.0	63.0	54.0	850	093546	P90543	€29.40
910546	46	74.0	40.0	69.0	54.0	1005	093546	P90543	€37.50
910550	50	80.0	43.0	74.0	54.0	1220	093546	P90543	€37.90
910555	55	84.0	43.0	80.0	54.0	1470	093546	P90543	€49.50
910560	60	87.0	46.0	86.0	54.0	1610	093546	P90543	€66.00
910565	65	90.0	49.0	92.0	54.0	1890	093546	P90543	€70.80
910570	70	96.0	51.0	99.0	54.0	2355	093546	P90543	€82.60
910575	75	98.0	52.0	104.0	54.0	2455	095775	P90675	€110.60
910580	80	100.0	52.0	109.0	86.0	2550	095775	P90675	€113.00
910585	85	100.0	52.0	115.0	86.0	2650	095775	P90675	€120.00
910590	90	100.0	52.0	119.0	86.0	2750	095775	P90765	€128.00
910595	95	100.0	52.0	130.0	86.0	2850	095775	P90765	€145.00

TENGTOLS

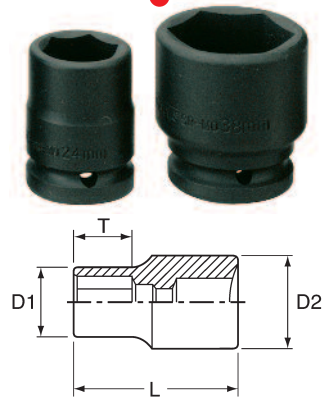

1" drive impact sockets thinwall deep 6 point metric, with locking pin and retaining ring facility. Chrome molybdenum. DIN standard for industrial use.

Stock No.	Size mm	L mm	T mm	D1 mm	D2 mm	Weight g	Retaining Ring	Retaining Pin	Price
910624	24	100.0	28.0	38.0	54.0	830	093546	P90543	€62.60
910627	27	100.0	49.0	43.0	54.0	895	093546	P90543	€62.60
910628	28	100.0	49.0	43.0	54.0	895	093546	P90543	€62.60
910630	30	100.0	42.0	45.0	54.0	945	093546	P90543	€62.60
910632	32	100.0	45.0	47.0	54.0	935	093546	P90543	€62.60
910633	33	100.0	45.0	49.0	54.0	980	093546	P90543	€62.60
910636	36	100.0	66.0	52.0	54.0	870	093546	P90543	€62.60

TENGTOLS





Impact Tools

1" Drive Impact Sockets

1" drive impact sockets deep 6 point metric, with locking pin and retaining ring facility. Chrome molybdenum. DIN standard for industrial use.

TENGTTOOLS

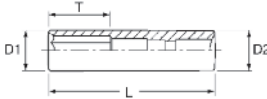

Stock No.	Size mm	L mm	T mm	D1 mm	D2 mm	Weight g	Retaining Ring	Retaining Pin	Price
910627R	27	100.0	50.0	46.0	54.0	990	093546	P90543	€38.60
910630R	30	100.0	50.0	50.0	54.0	1040	093546	P90543	€38.60
910632R	32	100.0	50.0	52.0	54.0	1060	093546	P90543	€38.60
910633R	33	100.0	50.0	53.0	54.0	1070	093546	P90543	€38.60

Hex impact sockets

3/8" drive hex impact socket bits. Made of chrome molybdenum. With locking pin and retaining ring facility.

TENGTTOOLS

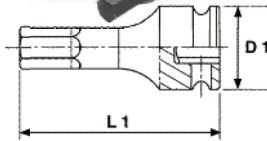

Stock No.	Size mm	L1 mm	D1 mm	Weight g	Retaining Ring	Retaining Pin	Price
981504-C	4	52.0	20.8	55	0935202	P90320	€9.10
981505-C	5	52.0	20.8	57	0935202	P90320	€9.10
981506-C	6	52.0	20.8	60	0935202	P90320	€9.10
981507-C	7	52.0	20.8	63	0935202	P90320	€9.10
981508-C	8	52.0	20.8	67	0935202	P90320	€9.10
981510-C	10	52.0	20.8	74	0935202	P90320	€9.70
981512-C	12	52.0	20.8	85	0935202	P90320	€9.70

1/2" drive hex impact socket bits. Made of chrome molybdenum with locking pin and retaining ring facility.

TENGTTOOLS

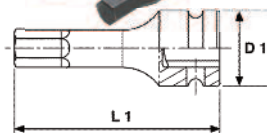

Stock No.	Size mm	L1 mm	D1 mm	Weight g	Retaining Ring	Retaining Pin	Price
921505-C	5	78.0	25.0	81	0935202	P90320	€12.50
921506-C	6	78.0	25.0	86	0935202	P90320	€12.50
921508-C	8	78.0	25.0	100	0935202	P90320	€12.50
921510-C	10	78.0	25.0	114	0935202	P90320	€13.10
921512-C	12	78.0	25.0	132	0935202	P90320	€13.10
921514-C	14	78.0	25.0	155	0935202	P90320	€13.10
921517-C	17	78.0	25.0	191	0935202	P90320	€13.60
921519-C	19	78.0	25.0	216	0935202	P90320	€13.60

3/4" drive impact hex socket bit, with locking pin and retaining ring facility. Chrome molybdenum.

TENGTTOOLS

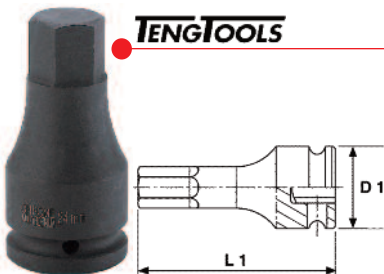

Stock No.	Size mm	L1 mm	D1 mm	Weight g	Retaining Ring	Retaining Pin	Price
941519-C	19	90.0	44.0	600	093538	P90437	€49.20
941522-C	22	90.0	44.0	600	093538	P90437	€49.20
941524-C	24	90.0	44.0	600	093538	P90437	€49.20