

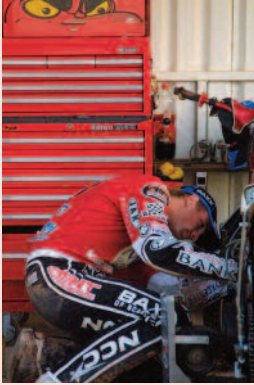

Sockets & Accessories



Ratchets

A choice of ratchets is available from a stubby 1/4" palm ratchet to a choice of 1" drive ratchets. In 1/4", 3/8" and 1/2" drive a choice of styles is available with the new Teng Tools 60 teeth ratchet and the FRP ratchets each having quick release and reverse action but with a choice of handle and head styles to suit personal choice and needs.

The heavy duty 3/4" and 1" drive ratchets are manufactured to full professional quality standards and feature removable heads and flip reverse system with the 3/4" drive option also featuring a quick release mechanism. 72 teeth 3/4" and 1" drive ratchets are also available with twist reverse and quick release for added convenience.



Mini Bits Ratchet

A 1/2" hex drive reversible ratchet with 8mm 12 point ring spanner. Drop forged. Chrome vanadium. Satin finish.



Stock No	PRICE
1400B	€25.40

Mini palm ratchet

Mini palm ratchet in 1/4" drive - ideal for use where space is very restricted. Reversible action.



Stock No	PRICE
1400M	€26.00

Stubby ratchet

Stubby type ratchet with flexible head and 72 teeth. This provides a 5 degree increment. Quick release and flip reverse system. All parts in the ratchet mechanism are easy to change. A ratchet for narrow spaces and where smooth action is required.

Drive	Stock no.	DIN	Description	Number of teeth	Length mm	Weight g
1/4"	1400-72ST	3122D	1/4" drive stubby ratchet handle 72 teeth, quick release and flip reverse system and flexible head	72	142	120



Stock No	PRICE
1400-72ST	€46.50

60 teeth ratchets

- Ultra slim type ratchet heads for much easier access in confined spaces
- 60 teeth providing a 6 degree increment for a smooth action
- Engages on multiple teeth for added strength and torque
- Quick release mechanism for releasing sockets and accessories with one hand
- Flip reverse lever for simple changing of direction
- All individual parts as well as service repair kits are available and easy to fit



60 Teeth ratchets

Ultra slim ratchet heads with 60 teeth giving a 6 degree increment between clicks. Quick release and flip reverse mechanism. Fewer moving parts for reliability and easier servicing. The ideal ratchet for narrow spaces and where a smooth action is required.



TENGTOLS

Stock No.	Drive	DIN	Description	Number of teeth	Length mm	Weight g	Price
1400-60T	¼"	3122D	ratchet with quick release	60	143	188	€33.00
3800-60T	⅜"	3122D	ratchet with quick release	60	200	232	€39.90
1200-60T	½"	3122D	ratchet with quick release	60	250	401	€48.00

72 Teeth ratchets

The heavy duty ¾" and 1" drive ratchets with 72 teeth are manufactured to full professional quality standards and feature twist reverse action. They also feature a quick release button for added convenience.



TENGTOLS

Stock No	Drive	Description	Number of teeth	length mm	Weight g	Price
M3400-72	¾"	¾" drive ratchet with twist reverse and quick release	72	505	2000	€135.00
M1100-72	1"	1" drive ratchet with twist reverse and quick release	72	800	4060	€225.00

FRP ratchets

- Steel reinforced fibre ratchets that are lighter than conventional ratchets but just as strong
- 45 teeth (8 degree increment) ratchet mechanism engages on multiple teeth for added strength and torque
- Quick release mechanism for releasing sockets and accessories with one hand
- Flip reverse lever for simple changing of direction
- Design protected (24583ROC)
- Two component handle with ergonomic design making the ratchet much more comfortable to use particularly in cold environments
- All individual parts as well as service repair kits are available and easy to fit
- Suitable for use on it's own or with Teng Tools TC tray sets as well as the Mecca Rosso range of socket and tool set

FRP Ratchets

Teng Tools steel reinforced fibre ratchets have been designed to create a 45 teeth (8 degree increment) ratchet with quick release and flip reverse to meet or exceed all internationally recognised quality and torque specifications. The design protected ratchet (24583ROC) is not only lighter and just as strong but is also much more comfortable to use than regular ratchets. New style bi-material handles for a more comfortable grip.



TENGTOLS

Stock No	Drive	DIN	Description	Maximum recommended torque	Number of teeth	length mm	Weight g	Price
1400FRP	⅜"	3122D	⅜" drive fibre reinforced ratchet handle with flip reverse and quick release	62Nm	45	150	100	€29.00
3800FRP	½"	3122D	½" drive fibre reinforced ratchet handle with flip reverse and quick release	202Nm	54	203	344	€36.90
1200FRP	¾"	3122D	¾" drive fibre reinforced ratchet handle with flip reverse and quick release	512Nm	54	254	684	€45.50



Sockets & Accessories



Heavy Duty Ratchets

The heavy duty 3/4" and 1" drive ratchets are manufactured to full professional quality standards and feature removable heads and flip reverse action. The 3/4" drive version also features a quick release button for added convenience. Knurled handle.

Stock No	Drive	DIN	Description	Number of teeth	length mm	Weight g	Price
M3400-3	3/4"	3122D	ratchet with detachable head	40	500	2570	€118.00
M1100	1"	3122D	ratchet with detachable head	24	665	4410	€138.90
M110010	1"	3122D	detachable ratchet head	24	165	1740	€119.60
M110020	1"	-	22" power bar for use with M110010	-	560	2670	€46.50

Specialist Ratchets

3/8" drive ratchet for push through sockets with flip reverse action. Two component handle with non slip sections, to be used together with push through sockets.



Stock No	PRICE
M800010	€43.80

400mm long 1/2" drive flexible ratchet featuring twist reverse and quick release function and a 60 teeth ratchet. Two component handle with non slip sections. Satin finish.



Stock No	PRICE
1200F	€59.60

400mm long 1/2" drive ratchet featuring twist reverse and quick release function and a 60 teeth ratchet. Two component handle with non slip sections. Satin finish.



Stock No	PRICE
1200L	€51.00

Repair kits

Repair kits for ratchets.

Stock No.	Description	Drive	Price
1400-72STRK	Repair Kit for 1400-72ST	3/4"	€17.60
1400-72RK	Repair Kit for 1400-72	3/4"	€19.50
1400-60TRK	Repair kit for 1400-60T	3/4"	€22.20
1400RK-1	Repair Kit for PT1400	3/4"	€9.90
1400FRPRK	Repair Kit for 1400FRP	3/4"	€11.60
1400NRK	Repair Kit for 1400	3/4"	€11.90
3800-72RK	Repair Kit for 3800-72	3/8"	€20.60
3800-60TRK	Repair kit for 3800-60T	3/8"	€19.30
3800RK-1	Repair Kit for PT3800	3/8"	€11.60
3800FRPRK	Repair Kit for 3800FRP	3/8"	€13.50
3800NRK	Repair Kit for 3800	3/8"	€13.50
1200-72RK	Repair Kit for 1200-72	1/2"	€22.50
1200-60TRK	Repair kit for 1200-60T	1/2"	€27.90
1200RK-1	Repair Kit for PT1200	1/2"	€16.00
1200FRPRK	Repair Kit for 1200FRP	1/2"	€15.40
1200NRK	Repair Kit for 1200	1/2"	€15.10
1201RK	Repair Kit for 1201	1/2"	€14.20
1200FRK	Repair Kit for 1200F and 1200L	1/2"	€16.50
M3400-72RK	Repair Kit for M3400-72	3/4"	€63.60
M3400-3RK	Repair Kit for M3400-3	3/4"	€57.50
M1100-72RK	Repair Kit for M1100-72	1"	€74.20
M1100RK	Repair Kit for M1100	1"	€53.00





Extension bars

Chrome vanadium steel. Satin finish.



TENGTTOOLS

Stock No.	Drive	Type	DIN	Description	Length mm	Weight g	Price
M140020-C	1/4"	A	3123B	2" extension bar	50	22	€3.80
M140023-C	1/4"	A	3123B	3" extension bar	75	35	€4.40
M140021-C	1/4"	A	3123B	4" extension bar	100	46	€4.40
M140022-C	1/4"	A	3123B	6" extension bar	150	65	€4.80
M140038-C	1/4"	-	3123B	6" flexible extension bar with protective cover	150	26	€11.50
M380020-C	3/8"	A	3123B	3" extension bar	75	75	€4.80
M380023-C	3/8"	A	3123B	5" extension bar	125	120	€6.50
M380021-C	3/8"	A	3123B	6" extension bar	150	145	€6.20
M380022-C	3/8"	A	3123B	10" extension bar	254	242	€10.00
M120020-C	1/2"	A	3123B	2 1/2" extension bar	63.5	105	€7.20
M120021-C	1/2"	A	3123B	5" extension bar	125	222	€8.50
M120023-C	1/2"	A	3123B	6" extension bar	150	240	€8.10
M120022-C	1/2"	A	3123B	10" extension bar	255	420	€13.10
M340020-C	3/4"	A	3123B	4" extension bar	100	400	€16.00
M340020S-C	3/4"	A	3123B	4" extension bar with safety locking mechanism	100	450	€24.00
M340021-C	3/4"	A	3123B	8" extension bar	200	700	€23.00
M340021S-C	3/4"	A	31123B	8" extension abr with safety locking mechanism	200	750	€27.80
M340022-C	3/4"	A	3123B	16" extension bar	400	1400	€32.00
M340022S-C	3/4"	A	3123B	16" extension bar with safety locking mechanism	400	1400	€40.10
M110040	1"	A	3123B	8" extension bar	200	1350	€53.00
M110050	1"	A	3123B	16" extension bar	400	2400	€66.20



TENGTTOOLS

Stock No.	Drive	Type	DIN	Description	Length mm	Weight g	Price
M380020W-C	3/8"	B	-	3" wobble extension bar	75	63	€8.20
M380021W-C	3/8"	B	-	6" wobble extension bar	150	145	€10.40
M380022W-C	3/8"	B	-	10" wobble extension bar	255	234	€13.00
M120020W-C	1/2"	B	-	3" wobble extension bar	75	105	€10.30
M120021W-C	1/2"	B	-	6" wobble extension bar	150	240	€13.10
M120022W-C	1/2"	B	-	10" wobble extension bar	255	420	€16.90



TENGTTOOLS

Stock No.	Drive	Type	DIN	Description	Length mm	Weight g	Price
M140024-C	1/4"	C	3123B	12" extension bar	305	126	€11.40
M380024-C	3/8"	C	3123B	20" extension bar	500	506	€21.10
M120024-C	1/2"	C	3123B	20" extension bar	500	855	€28.00



TENGTTOOLS

Stock No.	Drive	Type	DIN	Description	Length mm	Weight g	Price
M800023-C	3/8"	D	-	3" push through extension bar with 19mm external hex fitting	75	100	€9.50



Sockets & Accessories



TENGTOLS

Universal Joints

Chrome vanadium steel. Satin finish.

Stock No.	Drive	DIN	Description	Length mm	Weight g	Price
M140030-C	1/4"	3123C	1/4" drive universal joint	33	23	€12.30
M380030-C	3/8"	3123C	3/8" drive universal joint	50	65	€13.80
M120030-C	1/2"	3123C	1/2" drive universal joint	69	165	€16.90
M340030-C	3/4"	3123C	3/4" drive universal joint	115	570	€44.00

Adaptors

Chrome vanadium. Socket converters with T handle hole facility on most popular sizes. Satin finish.



TENGTOLS

Stock No.	Drive	DIN	Description	T drive facility	Length mm	Weight g	Price
M140036-C	-	1/4"	1/4" female: 3/8" male adaptor	No	25.0	20	€3.70
M140037	-	1/4"	1/4" male: 1/4" hex adaptor	No	25.0	3	€4.20
M380035-C	3123A	3/8"	3/8" female: 1/4" male adaptor	Yes	25.4	20	€7.00
M380036-C	3123A	3/8"	3/8" female: 1/2" male adaptor	Yes	36.0	45	€7.20
M380037	-	3/8"	hex:3/8" male adaptor	No	32.0	14	€7.00
M120036-C	3123A	1/2"	1/2" female: 3/4" male adaptor	Yes	39.5	55	€6.30
M120037-C	3123A	1/2"	1/2" female: 1" male adaptor	No	39.5	55	€13.10
M340085-C	-	3/4"	3/4" female: 1" male adaptor	No	62.0	370	€20.50
M340086-C	3123A	3/4"	3/4" female: 1/2" male adaptor	Yes	40.0	52	€18.60
M110030	-	1"	1" drive T bar adaptor	Yes	82.0	620	€32.00

Coupler Adaptors

Coupler adaptors for Teng Tools bits.

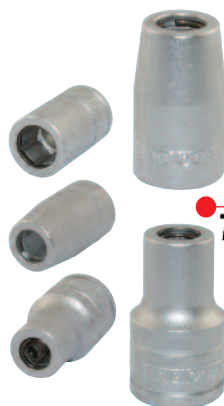

TENGTOLS

Stock No.	Drive	DIN	Description	Length mm	Weight g	Price
M140060-C	1/4"	3126	coupler adaptor for 1/4" hex bits	25	20	€4.40
M380060-C	3/8"	3126	coupler adaptor for 3/8" hex bits	28	32	€5.00
M380061-C	3/8"	3126	coupler adaptor for 10mm hex bits	28	32	€6.40
M120060-C	1/2"	3126	coupler adaptor for 9/16" hex bits	38	88	€6.60
M120061-C	1/2"	3126	coupler adaptor for 10mm hex bits	38	56	€8.70
M120062-C	1/2"	3126	coupler adaptor for 12mm hex bits	38	62	€9.70



TENGTOLS

Sliding T bars

Chrome vanadium steel. Satin finish.

Stock No.	Drive	DIN	Description	Length mm	Weight g	Price
M140050-C	1/4"	3122A	1/4" drive sliding T Bar	106	40	€5.40
M380050-C	3/8"	3122A	3/8" drive sliding T Bar	170	122	€14.50
M120050-C	1/2"	3122A	1/2" drive sliding T Bar	243	300	€13.80
M340050-C	3/4"	3122A	3/4" drive sliding T Bar	450	450	€38.90
M340050S-C	3/4"	3122A	3/4" drive sliding T Bar with safety locking mechanism	450	450	€49.20

All prices exclude VAT and are subject to availability



Speed Braces

Chrome vanadium steel. Satin finish. Plastic handle.



Stock No.	Drive	DIN	Description	Length mm	Weight g	Price
M380011-C	3/8"	-	speed brace	380	310	€18.10
M120011-C	1/2"	-	speed brace	420	585	€26.10

Drivers

MD514 Flexible screwdriver handle with 1/4" square drive for bit sockets and standard sockets. Black plastic handle with external hexagonal grip for tightening with a spanner. Only for right hand action (permitted load 5 Nm).

M140015-C and M380015-C with square drive for sockets and socket tools the handle part has internal square drive for connection, e.g. a T handle.

PT3810R with 3/8" square drive for sockets and socket tools. Two part plastic handle. Handle part has internal 3/8" square drive for connection, e.g. a T handle.

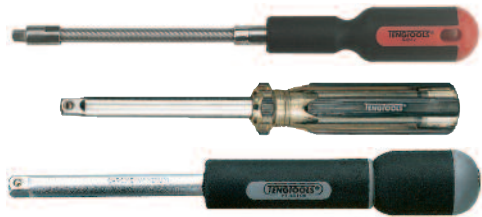

Stock No.	Drive	DIN	Description	Length mm	Weight g	Price
MD514	1/4"	-	flexi handle	275	100	€11.60
M140015-C	1/4"	3122E	6" spinner handle	150	80	€11.40
M380015-C	3/8"	3122E	10" spinner handle	255	280	€17.10
PT3810R	3/8"	3122E	rotating spinner handle extension with power drive	253	302	€18.50

TT Tray

Set containing 10 12 point deep 1/2" drive sockets and 10" flex handle. Supplied in the Teng Tools TC tray with removable lid. Supplied in the Teng Tools TC tray with removable lid.

TT1211	11 piece 1/2" drive deep metric 12 point socket set (265x142x50mm, 2.0 kilos)
Accessories	1/2" drive 10" flex handle
Deep sockets	1/2" drive 12 point 10, 11, 12, 13, 14, 15, 16, 17, 18, 19mm



Stock No	PRICE
TT1211	€83.10



Flex Handles

Chrome vanadium steel. Satin finish. Two component handle.

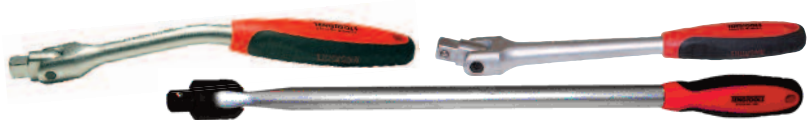

Stock No.	Drive	DIN	Description	Length mm	Weight g	Price
M380010A-C	3/8"	-	10" flex handle	250	375	€20.90
M120010-C	1/2"	3122F	10" flex handle	265	492	€25.80
1201	1/2"	-	17" flex handle	450	894	€40.00
1201A	1/2"	-	24" flex handle	600	1198	€58.70
M340070-C	3/4"	3122F	19" flex handle	480	1880	€67.00
M340070S-C	3/4"	3122F	19" flex handle with safety locking mechanism	480	1880	€72.40



Sockets & Accessories



TENGTOLS

Spark Plug Sockets

6 point chrome vanadium sockets, with rubber insert. Satin finish.

Stock No.	Drive	Description	Thread size	Length mm	Weight g	Price
M380040-C	3/8"	6 point 16mm spark plug socket	10	64	100	€5.70
M380041-C	3/8"	6 point 16mm flexible spark plug socket	10	85	117	€11.80
M380042-C	3/8"	6 point 18mm spark plug socket	12	70	130	€5.90
M380046-C	3/8"	6 point 21mm spark plu socket	14	70	160	€6.40
M380047-C	3/8"	6 point 21mm flexible spark plug socket	14	91	169	€13.20
M120040-C	1/2"	6 point 16mm spark plug socket	10	70	165	€7.00
M120042-C	1/2"	6 point 18mm spark plug socket	12	70	165	€7.50
M120046-C	1/2"	6 point 21mm spark plug socket	14	70	165	€7.70



TENGTOLS

Miscellaneous

Stock No.	Drive	DIN	Description	Length mm	Weight g	Price £
M120080-C	1/2"	-	1/2" drive flex head adaptor	70	188	€16.30
T-HD	3/8"	-	for use with extension bars to form a comfortable to use T handle	120	32	€6.80

Square drives – sockets and accessories

The socketry range covers 1/4" through to 1" drive and includes 6 point and 12 point, metric and AF as well as TX-E. A wide selection of bit sockets for hex, TX and TPX is further complimented by a range of bit adaptors for use with the extensive range of bits featured in the screwdriver section of this catalogue.

- All Teng Tools sockets and accessories are individually branded and made from high quality chrome vanadium steel to conform to all the latest DIN and ISO standards.
- Each socket and accessory is supplied on a PP card which for 1/4", 3/8" and 1/2" drive includes a socket clip for use on the Teng Tools aluminium clip rails enabling users to build their own individual clip rail sets to suit their own specific requirements.
- Extensions are available with wobble or square ends
- Safety locking system in 3/4" drive to prevent sockets detaching from extension bars accidentally.
- All sockets feature the Teng Tools "hip grip" system where the socket drives on the flat rather than on the corner. A system that helps prevent damage to fastenings and helps grip nuts and bolts where the hexagon has been previously damaged.
- Grub screw fixings on many accessories for added security when working in hard to reach places.
- 3 way adaptors that convert from one drive to another but also include a T bar facility using a Teng Tools extension bar.
- Spinner handles with a female drive for added torque.

1/4" Drive Sockets

1/4" drive metric sockets, regular, 6 point, DIN 3120/3124/ISO 2725 Chrome Vanadium. Satin Finish.



TENGTOLS

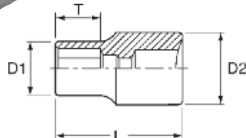

Stock no.	Size	L mm	T mm	D1 mm	D2 mm	Weight g	Price
M140504-C	4	21.2	3.6	6.9	12.0	10	€3.60
M1405045-C	4.5	21.2	3.6	7.5	12.0	12	€3.60
M140505-C	5	21.2	4.2	8.1	12.0	12	€3.60
M1405055-C	5.5	21.2	4.2	8.8	12.0	12	€3.60
M140506-C	6	21.2	4.8	9.4	12.0	12	€3.60
M140507-C	7	21.2	4.0	10.9	12.0	13	€3.60
M140508-C	8	21.2	4.0	12.0	12.0	13	€3.60
M140509-C	9	21.2	4.5	13.2	13.2	18	€3.60
M140510-C	10	21.2	6.0	14.7	14.7	19	€3.60
M140511-C	11	21.2	6.0	16.0	16.0	22	€3.60
M140512-C	12	21.2	7.0	16.9	16.9	25	€3.60
M140513-C	13	21.2	7.5	17.7	17.7	28	€3.60

All prices exclude VAT and are subject to availability



1/4" Drive Sockets

1/4" drive AF sockets, regular 6 point, DIN 3120/3124/ISO 2725
Chrome vanadium. Satin Finish.

Stock no.	Size AF	L mm	T mm	D1 mm	D2 mm	Weight g	Price
M140106-C	3/16"	21.2	3.6	8.0	12.0	12	€3.60
M140107-C	7/32"	21.2	4.2	8.8	12.0	12	€3.60
M140108-C	1/4"	21.2	4.8	10.0	12.0	12	€3.60
M140109-C	9/32"	21.2	4.0	10.9	12.0	13	€3.60
M140110-C	5/16"	21.2	4.0	12.0	12.0	13	€3.60
M140111-C	11/32"	21.2	4.5	13.2	13.2	18	€3.60
M140112-C	3/8"	21.2	4.5	14.7	14.4	19	€3.60
M140114-C	7/8"	21.2	6.0	16.0	16.0	22	€3.60
M140116-C	1/2"	21.2	7.2	17.7	17.7	28	€3.60

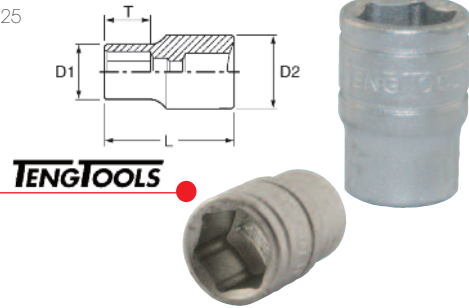

1/4" drive metric sockets, deep 6 point, DIN 3120/3124/ISO 2725
Chrome vanadium, Satin Finish.

Stock no.	Size mm	L mm	T mm	D1 mm	D2 mm	Weight g	Price
M140604-C	4	49.5	5.0	8.0	11.8	23	€5.20
M140605-C	5	49.5	5.5	8.0	11.8	25	€5.20
M1406055-C	5.5	49.5	5.5	8.8	11.8	26	€5.20
M140606-C	6	49.5	6.5	9.4	11.8	26	€5.20
M140607-C	7	49.5	10.5	10.9	11.8	27	€5.20
M140608-C	8	49.5	10.5	11.8	11.8	30	€5.20
M140609-C	9	49.5	11.5	12.8	12.8	37	€5.20
M140610-C	10	49.5	13.0	14.5	14.5	38	€5.20
M140611-C	11	49.5	14.0	15.6	15.6	43	€5.20
M140612-C	12	49.5	15.0	16.6	16.6	46	€5.20
M140613-C	13	49.5	17.0	17.6	17.6	48	€5.20

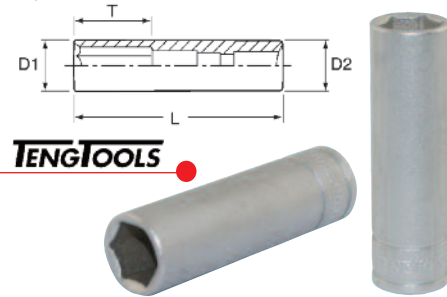

1/4" drive AF sockets, deep 6 point, DIN 3120/3124/ISO 2725
Chrome vanadium. Satin Finish.

Stock no.	Size AF	L mm	T mm	D1 mm	D2 mm	Weight g	Price
M140206-C	3/16"	49.5	5.0	8.0	11.8	24	€5.20
M140207-C	7/32"	49.5	5.5	8.8	11.8	26	€5.20
M140208-C	1/4"	49.5	6.5	10.0	11.8	27	€5.20
M140209-C	9/32"	49.5	5.5	8.8	11.8	26	€5.20
M140210-C	5/16"	49.5	10.5	11.8	11.8	30	€5.20
M140211-C	11/32"	49.5	11.5	12.8	11.8	34	€5.20
M140212-C	3/8"	49.5	12.5	14.5	14.5	37	€5.20
M140214-C	7/16"	49.5	14.5	15.8	15.8	44	€5.20
M140216-C	1/2"	49.5	16.5	17.6	17.6	48	€5.20

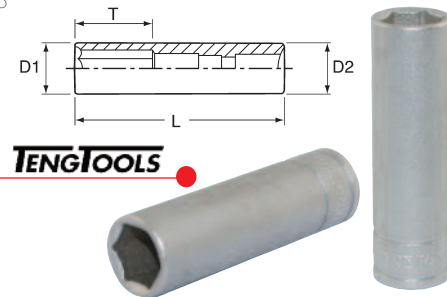

1/4" drive TX-E sockets. Chrome vanadium. Satin Finish.

Stock no.	Size	Size mm	L mm	T mm	D1 mm	D2 mm	Weight g	Price
M140704-C	E4	3.86	23.1	3.5	12.0	12.0	7	€3.90
M140705-C	E5	4.75	24.8	4.5	12.0	12.0	8	€3.90
M140706-C	E6	5.74	24.8	4.5	12.0	12.0	9	€3.90
M140707-C	E7	6.22	24.8	5.6	12.0	12.0	10	€3.90
M140708-C	E8	7.52	24.8	6.0	12.0	12.0	10	€3.90

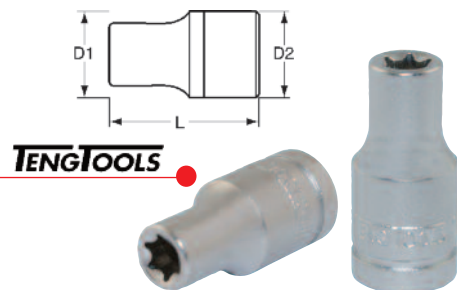



Sockets & Accessories

1/4" Drive Sockets

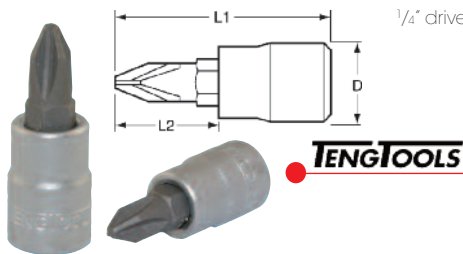

1/4" drive PH S2 socket bits DIN 5260 Chrome vanadium. Satin Finish.

Stock no.	Size	L1 mm	L2 mm	D mm	Weight g	Price
M141300-C	PH0	32.0	15.0	12.0	13	€3.60
M141301-C	PH1	32.0	15.0	12.0	13	€3.60
M141302-C	PH2	32.0	15.0	12.0	13	€3.60
M141303-C	PH3	32.0	15.0	12.0	13	€3.60

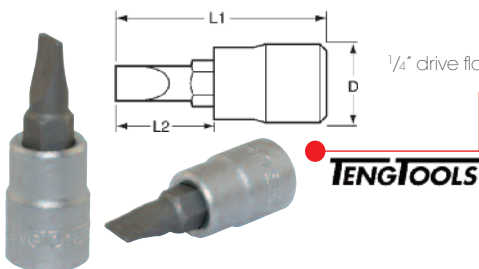

1/4" drive flat S2 socket bits DIN 5264. Chrome vanadium. Satin Finish.

Stock no.	Width mm	Thickness mm	L1 mm	L2 mm	D mm	Weight g	Price
M141404-C	4.0	0.76	32.0	15.0	12.0	13	€3.60
M1414055-C	5.5	0.99	32.0	15.0	12.0	13	€3.60
M141407-C	7.0	1.4	32.0	15.0	12.0	14	€3.60

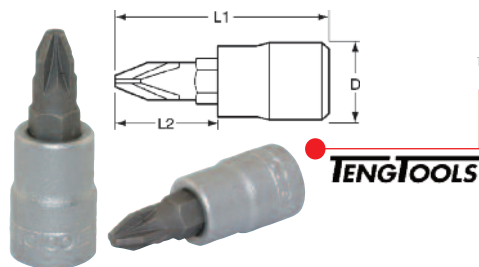

1/4" drive PZ S2 socket bits. Chrome vanadium. Satin Finish.

Stock No.	Size	L1 mm	L2 mm	D mm	Weight g	Price
M141601-C	PZ1	32.0	15.0	12.0	13	€3.60
M141602-C	PZ2	32.0	15.0	12.0	13	€3.60
M141603-C	PZ3	32.0	15.0	12.0	13	€3.60

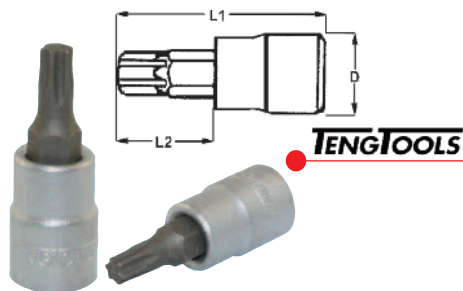

1/4" drive TX S2 socket bits. Chrome vanadium. Satin Finish.

Stock no.	Size	Size mm	L1 mm	L2 mm	D mm	Weight g	Price
M141210T-C	TX10	2.5	32.0	15.0	12.0	13	€3.60
M141215T-C	TX15	3.0	32.0	15.0	12.0	13	€3.60
M141220T-C	TX20	3.5	32.0	15.0	12.0	13	€3.60
M141225T-C	TX25	4.5	32.0	15.0	12.0	13	€3.60
M141227T-C	TX27	5.0	32.0	15.0	12.0	14	€3.60
M141230T-C	TX30	5.5	32.0	15.0	12.0	14	€3.60
M141240T-C	TX40	6.5	32.0	15.0	12.0	14	€3.60



3/8" Drive Sockets

3/8" drive metric sockets regular 6 point, DIN 3120/3124/ISO 2725.
Chrome vanadium. Satin Finish.

Stock no.	Size mm	L mm	T mm	D1 mm	D2 mm	Weight g	Price
M380507-C	7	25.7	4.0	10.8	17.1	21	€3.70
M380508-C	8	25.7	4.5	12.0	17.1	25	€3.70
M380509-C	9	25.7	5.0	13.1	17.1	26	€3.70
M380510-C	10	25.7	5.0	14.7	17.1	26	€4.10
M380511-C	11	25.7	7.0	16.0	17.1	26	€4.10
M380512-C	12	25.7	7.0	17.1	17.1	29	€4.10
M380513-C	13	25.7	7.0	18.3	18.3	32	€4.10
M380514-C	14	25.7	9.0	19.5	19.5	40	€4.10
M380515-C	15	25.7	10.0	20.4	20.4	43	€4.10
M380516-C	16	29.0	10.0	22.1	22.1	43	€4.50
M380517-C	17	29.0	10.0	23.3	23.3	50	€4.50
M380518-C	18	29.0	15.5	24.2	20.0	56	€4.80
M380519-C	19	29.0	15.5	25.7	21.0	64	€5.00
M380520-C	20	29.0	15.5	26.7	22.0	71	€5.20
M380521-C	21	29.0	15.5	27.7	23.0	78	€5.40
M380522-C	22	29.0	15.5	29.8	24.0	82	€5.40

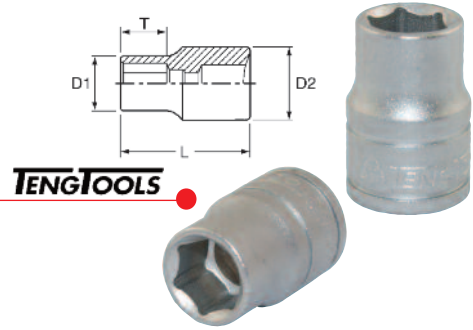

3/8" drive AF sockets regular 6 point, DIN 3120/3124/ISO 2725.
Chrome vanadium. Satin Finish.

Stock no.	Size AF	L mm	T mm	D1 mm	D2 mm	Weight g	Price
M380110-C	5/16"	25.7	4.5	11.7	17.1	23	€3.90
M380112-C	3/8"	25.7	5.0	14.2	17.1	24	€3.90
M380114-C	7/16"	25.7	7.0	16.3	17.1	26	€3.90
M380116-C	1/2"	25.7	7.0	18.3	18.3	34	€4.20
M380118-C	9/16"	25.7	9.0	19.5	19.5	38	€4.20
M380120-C	5/8"	29.0	10.0	22.1	22.1	46	€4.20
M380122-C	11/16"	29.0	10.0	24.2	20.0	50	€4.40
M380124-C	3/4"	29.0	12.0	25.7	21.0	60	€4.80
M380126-C	13/16"	29.0	13.0	27.7	23.0	68	€4.80
M380128-C	7/8"	29.0	13.0	29.5	24.0	75	€5.00

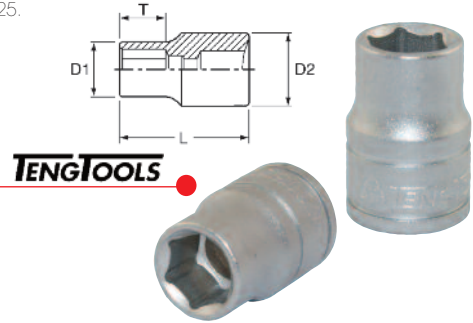

3/8" drive metric sockets deep 6 point, DIN 3120/3124/ISO 2725.
Chrome vanadium. Satin Finish.

Stock no.	Size mm	L mm	T mm	D1 mm	D2 mm	Weight g	Price
M380607-C	7	45.5	10.0	10.8	16.5	40	€6.60
M380608-C	8	45.5	12.0	12.0	16.5	50	€6.60
M380609-C	9	45.5	14.0	13.1	16.5	55	€6.60
M380610-C	10	45.5	15.0	14.7	16.5	60	€6.60
M380611-C	11	45.5	17.0	16.5	16.5	70	€6.60
M380612-C	12	45.5	18.0	17.1	17.1	75	€6.60
M380613-C	13	45.5	18.0	18.5	18.5	85	€6.60
M380614-C	14	50.0	18.0	19.5	19.5	95	€6.80
M380615-C	15	53.0	20.0	20.4	20.4	100	€6.80
M380616-C	16	53.0	20.0	22.0	22.0	105	€7.90
M380617-C	17	56.0	20.0	23.3	23.3	120	€7.90
M380618-C	18	56.0	20.0	24.2	23.0	125	€7.90
M380619-C	19	56.0	20.0	25.7	24.0	130	€8.90
M380620-C	20	63.5	22.0	26.8	25.0	140	€8.90
M380621-C	21	63.5	22.0	27.7	26.0	165	€9.70
M380622-C	22	63.5	22.0	29.5	27.0	165	€9.70

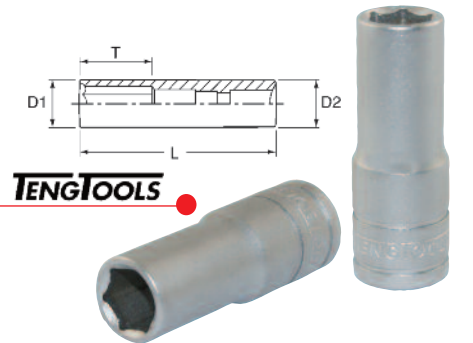



Sockets & Accessories

3/8" Drive Sockets

3/8" drive AF sockets deep 6 point, DIN 3120/3124/ISO 2725. Chrome vanadium, Satin Finish.

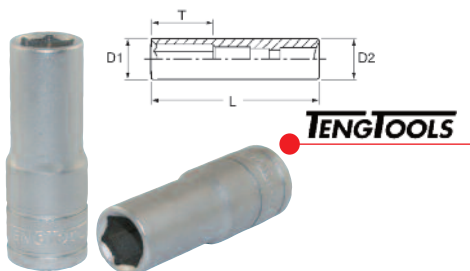

Stock no.	Size AF	L mm	T mm	D1 mm	D2 mm	Weight g	Price
M380212-C	3/8"	45.5	15.0	14.2	16.5	43	€6.20
M380214-C	7/16"	45.5	17.0	16.5	16.5	50	€6.20
M380216-C	1/2"	45.5	18.0	18.5	18.5	62	€6.20
M380218-C	9/16"	50.0	18.0	19.5	19.5	72	€6.20
M380220-C	5/8"	53.0	20.0	22.0	22.0	97	€7.00
M380222-C	11/16"	56.0	20.0	24.2	24.2	125	€7.50
M380224-C	3/4"	56.0	22.0	25.7	25.7	130	€8.10
M380226-C	7/8"	63.5	22.0	27.7	27.7	140	€9.10
M380228-C	1"	63.5	22.0	29.5	29.5	165	€9.70

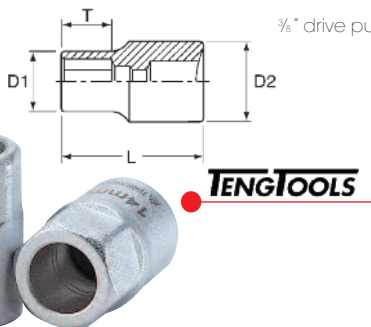

3/8" drive push through sockets, 6 point, ranging from 10 to 19mm. To be used with M800010. Satin finish.

Stock No.	Size mm	L mm	T mm	D1 mm	D2 mm	Weight g	Price
M800510-C	10	32.0	11.0	19.0	15.0	50	€7.90
M800511-C	11	32.0	11.0	19.0	16.5	50	€7.90
M800512-C	12	32.0	12.0	19.0	18.0	50	€8.20
M800513-C	13	32.0	13.0	19.0	19.0	50	€8.20
M800514-C	14	32.0	13.0	19.0	20.5	50	€8.20
M800515-C	15	32.0	13.0	19.0	21.0	50	€8.60
M800516-C	16	32.0	13.0	19.0	23.0	50	€9.40
M800517-C	17	32.0	13.0	19.0	24.0	50	€9.40
M800518-C	18	32.0	13.0	19.0	25.0	50	€9.80
M800519-C	19	32.0	13.0	19.0	26.0	50	€9.80

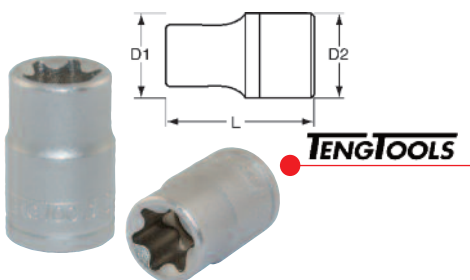

3/8" drive TX-E sockets, Chrome vanadium. Satin Finish.

Stock no.	Size	Size mm	L mm	T mm	D1 mm	D2 mm	Weight g	Price
M380710-C	E10	9.42	28.0	7.2	17.0	18	25	€4.60
M380712-C	E12	11.17	28.0	7.7	17.0	18	25	€4.60
M380714-C	E14	12.90	28.0	9.6	17.8	18	30	€4.60
M380716-C	E16	14.76	28.0	10.8	20.0	20	35	€4.60
M380718-C	E18	16.70	28.0	12.0	22.1	22	40	€4.60

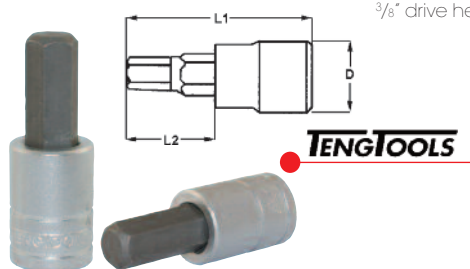

3/8" drive hex S2 socket bits. DIN 7422 Chrome vanadium. Satin Finish.

Stock no.	Size mm	L1 mm	L2 mm	D mm	Weight g	Price
M381503-C	3	49.5	23.0	17.9	38	€7.50
M381504-C	4	49.5	23.0	17.9	38	€7.50
M381505-C	5	49.5	23.0	17.9	38	€7.50
M3815055-C	5.5	49.5	23.0	17.9	38	€7.50
M381506-C	6	49.5	23.0	17.9	38	€7.50
M381507-C	7	49.5	23.0	17.9	40	€7.50
M381508-C	8	49.5	23.0	17.9	44	€7.50
M381510-C	10	49.5	23.0	17.9	52	€7.50
M381512-C	12	49.5	23.0	22.0	56	€7.80



3/8" Drive Sockets

3/8" drive hex S2 socket bits. Chrome vanadium. Satin Finish.

Stock no.	Size AF	L1 mm	L2 mm	D mm	Weight g	Price
M381103-C	3/32"	49.5	23.0	17.9	38	€7.40
M381104-C	1/8"	49.5	23.0	17.9	38	€7.40
M381105-C	5/32"	49.5	23.0	17.9	38	€7.40
M381106-C	3/16"	49.5	23.0	17.9	38	€7.40
M381107-C	7/32"	49.5	23.0	17.9	38	€7.40
M381108-C	1/4"	49.5	23.0	17.9	38	€7.40
M381110-C	5/16"	49.5	23.0	17.9	44	€7.40
M381112-C	3/8"	49.5	23.0	17.9	44	€7.40

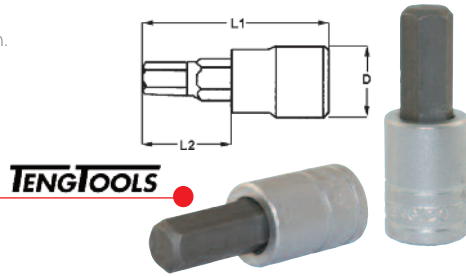

3/8" drive TPX socket bits. Chrome vanadium. Satin Finish.

Stock no.	Size	Size	L1 mm	L2 mm	D mm	Weight g	Price
M381210-C	TPX10	2.5	49.5	23.0	17.9	38	€7.40
M381215-C	TPX15	3.0	49.5	23.0	17.9	38	€7.40
M381220-C	TPX20	3.5	49.5	23.0	17.9	38	€7.40
M381225-C	TPX25	4.5	49.5	23.0	17.9	38	€7.40
M381227-C	TPX27	5.0	49.5	23.0	17.9	38	€7.40
M381230-C	TPX30	5.5	49.5	23.0	17.9	38	€7.40
M381240-C	TPX40	6.5	49.5	23.0	17.9	38	€7.40
M381245-C	TPX45	7.5	49.5	23.0	17.9	38	€7.40
M381250-C	TPX50	8.8	49.5	23.0	17.9	38	€7.40

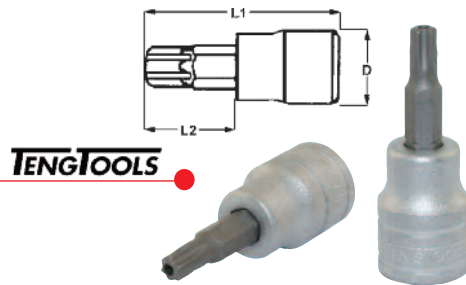

3/8" drive TX socket bits. Chrome vanadium. Satin Finish.

Stock no.	Size	Size	L1 mm	L2 mm	D mm	Weight g	Price
M381210T-C	TX10	2.5	49.5	23.0	17.9	38	€7.40
M381215T-C	TX15	3.0	49.5	23.0	17.9	38	€7.40
M381220T-C	TX20	3.5	49.5	23.0	17.9	38	€7.40
M381225T-C	TX25	4.5	49.5	23.0	17.9	38	€7.40
M381227T-C	TX27	5.0	49.5	23.0	17.9	38	€7.40
M381230T-C	TX30	5.5	49.5	23.0	17.9	38	€7.40
M381240T-C	TX40	6.5	49.5	23.0	17.9	38	€7.40
M381245T-C	TX45	7.5	49.5	23.0	17.9	38	€7.40
M381250T-C	TX50	8.8	49.5	23.0	17.9	38	€7.40

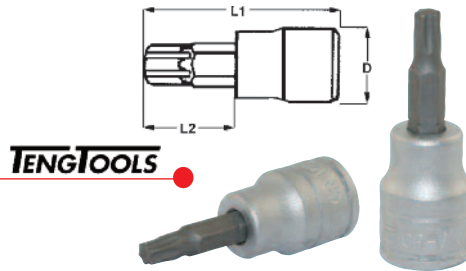

1/2" Drive Sockets

1/2" drive metric sockets regular 12 point, DIN 3120/3124/ISO 2725 Chrome vanadium. Satin Finish.

Stock no. mm	Size mm	L mm	T mm	D1 mm	D2 mm	Weight g	Price
M120508-C	8	38.0	9.0	13.0	21.8	43	€5.00
M120509-C	9	38.0	10.0	14.5	21.8	45	€5.00
M120510-C	10	38.0	10.0	15.5	21.8	47	€5.00
M120511-C	11	38.0	10.0	16.7	21.8	49	€5.00
M120512-C	12	38.0	10.0	18.0	21.8	51	€5.00
M120513-C	13	38.0	10.0	19.2	21.8	52	€5.00
M120514-C	14	38.0	10.0	20.5	21.8	52	€5.00
M120515-C	15	38.0	14.0	21.7	23.3	53	€5.70
M120516-C	16	38.0	14.3	22.5	23.3	62	€5.70
M120517-C	17	38.0	15.3	24.2	23.0	80	€5.70
M120518-C	18	38.0	16.7	24.7	23.0	82	€5.70
M120519-C	19	38.0	17.3	26.3	24.0	88	€5.70
M120520-C	20	38.0	18.0	27.7	25.0	96	€6.30
M120521-C	21	38.0	18.0	28.8	25.0	104	€6.30
M120522-C	22	40.0	18.0	29.0	26.0	113	€6.80
M120523-C	23	40.0	18.0	30.8	27.0	120	€6.80
M120524-C	24	40.0	20.0	31.8	27.0	126	€7.70
M120525-C	25	40.0	20.0	33.4	28.0	136	€8.40
M120526-C	26	40.0	20.0	34.8	29.0	140	€8.80
M120527-C	27	43.0	20.0	35.8	30.0	166	€9.10
M120528-C	28	43.0	20.0	37.8	31.0	172	€9.40
M120529-C	29	43.0	20.0	38.8	32.0	180	€9.70
M120530-C	30	43.0	22.0	39.8	33.0	191	€9.90
M120532-C	32	43.5	23.0	41.8	35.0	122	€11.30

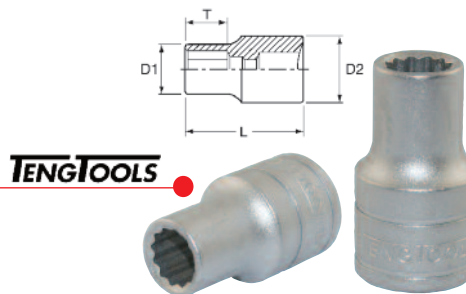



Sockets & Accessories

1/2" Drive Sockets

1/2" drive metric sockets regular 6 point, DIN 3120/3124/ISO 2725
Chrome vanadium. Satin Finish.

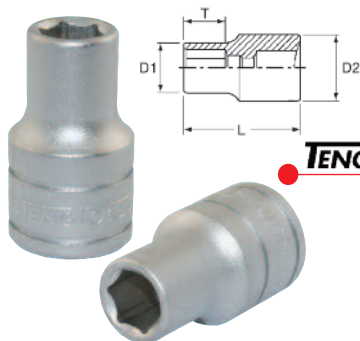

TENGTOLS

Stock no.	Size mm	L mm	T mm	D1 mm	D2 mm	Weight g	Price
M1205106-C	10	38.0	10.0	15.5	21.8	47	€5.00
M1205116-C	11	38.0	10.0	16.7	21.8	49	€5.00
M1205126-C	12	38.0	10.0	18.0	21.8	51	€5.00
M1205136-C	13	38.0	10.0	19.2	21.8	52	€5.00
M1205146-C	14	38.0	10.0	20.5	21.8	52	€5.00
M1205156-C	15	38.0	14.0	21.7	23.3	53	€5.70
M1205166-C	16	38.0	14.3	22.5	23.3	62	€5.70
M1205176-C	17	38.0	14.3	24.2	23.0	80	€5.70
M1205186-C	18	38.0	15.3	24.7	23.0	82	€5.70
M1205196-C	19	38.0	16.7	26.3	24.0	88	€5.70
M1205206-C	20	38.0	17.3	27.7	25.0	96	€6.30
M1205216-C	21	38.0	18.0	28.8	25.0	104	€6.30
M1205226-C	22	40.0	18.0	29.8	26.0	113	€6.80
M1205236-C	23	40.0	18.0	30.8	27.0	120	€6.80
M1205246-C	24	40.0	18.0	31.8	27.0	126	€7.70
M1205256-C	25	40.0	20.0	33.4	28.0	136	€8.40
M1205266-C	26	40.0	20.0	34.8	29.0	140	€8.80
M1205276-C	27	43.0	20.0	35.8	30.0	166	€9.10
M1205286-C	28	43.0	20.0	37.8	31.0	172	€9.40
M1205296-C	29	43.0	20.0	38.8	32.0	180	€9.70
M1205306-C	30	43.0	20.0	39.8	33.0	191	€9.90
M1205326-C	32	43.0	22.0	41.8	35.0	222	€11.30
M1205336-C	33	45.5	23.5	42.8	35.0	235	€11.40
M1205346-C	34	45.5	23.5	43.8	35.0	254	€11.70

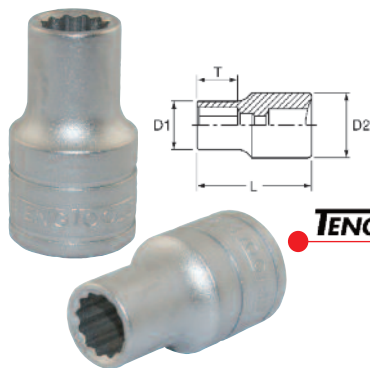

TENGTOLS

1/2" drive AF sockets regular 12 point, DIN 3120/3124/ISO 2725
Chrome vanadium. Satin Finish.

Stock no.	Size AF	L mm	T mm	D1 mm	D2 mm	Weight g	Price
M120112-C	3/8"	38.0	9.0	14.7	21.8	46	€5.00
M120114-C	7/16"	38.0	9.0	17.0	21.8	50	€5.00
M120116-C	1/2"	38.0	10.0	19.0	21.8	52	€5.00
M120118-C	9/16"	38.0	12.5	20.8	21.8	55	€5.00
M120120-C	5/8"	38.0	14.3	23.3	22.5	62	€5.70
M120122-C	11/16"	38.0	14.3	24.7	23.0	72	€5.70
M120124-C	3/4"	38.0	20.0	26.3	24.0	76	€5.70
M120126-C	7/8"	38.0	20.0	28.8	28.8	80	€6.20
M120128-C	15/16"	40.0	21.0	29.8	29.8	95	€6.30
M120130-C	1"	40.0	21.0	31.8	27.0	110	€6.70
M120132-C	1 1/16"	43.0	21.0	33.4	28.0	120	€7.50
M120134-C	1 1/8"	43.0	23.0	35.8	30.0	145	€8.90
M120136-C	1 1/4"	43.0	23.0	37.8	31.0	150	€9.20
M120138-C	1 3/8"	43.0	23.0	39.8	33.0	190	€9.80
M120140-C	1 1/2"	43.0	23.0	41.8	35.0	205	€10.50

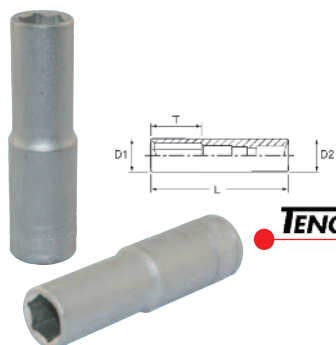

TENGTOLS

1/2" drive metric sockets deep 6 point, DIN 3120/3124/ISO 2725
Chrome vanadium. Satin Finish.

Stock no.	Size mm	L mm	T mm	D1 mm	D2 mm	Weight g	Price
M1206136-C	13	79.0	21.0	19.2	22.0	135	€10.20
M1206146-C	14	79.0	25.0	20.5	22.0	135	€10.40
M1206156-C	15	79.0	28.0	21.5	22.0	135	€10.50
M1206166-C	16	79.0	31.0	22.5	23.3	150	€10.50
M1206176-C	17	79.0	34.0	24.2	24.2	155	€10.50
M1206186-C	18	79.0	34.0	25.4	25.4	165	€10.50
M1206196-C	19	79.0	34.0	26.7	26.7	190	€10.50
M1206246-C	24	79.0	34.0	31.8	28.5	240	€10.90



1/2" Drive Sockets

1/2" drive metric sockets deep 12 point, DIN 3120/3124/ISO 2725. Chrome vanadium. Satin Finish.

Stock no.	Size mm	L mm	T mm	D1 mm	D2 MM	Weight G	Price
M120610-C	10	79.0	17.0	15.5	22.0	125	€9.70
M120611-C	11	79.0	18.0	16.7	22.0	130	€9.70
M120612-C	12	79.0	19.0	18.0	22.0	130	€9.70
M120613-C	13	79.0	21.0	19.2	22.0	135	€10.20
M120614-C	14	79.0	25.0	20.5	22.0	135	€10.40
M120615-C	15	79.0	28.0	21.5	22.0	135	€10.50
M120616-C	16	79.0	31.0	22.5	23.3	150	€10.50
M120617-C	17	79.0	24.0	24.2	24.2	155	€10.50
M120618-C	18	79.0	34.0	25.4	25.4	165	€10.50
M120619-C	19	79.0	34.0	26.7	26.7	190	€10.50
M120620-C	20	79.0	34.0	27.8	27.8	195	€10.50
M120621-C	21	79.0	34.0	27.8	27.8	200	€10.50
M120622-C	22	79.0	34.0	29.8	29.8	230	€10.50
M120624-C	24	79.0	34.0	31.8	28.5	240	€10.90
M120627-C	27	79.0	34.0	35.8	32.0	280	€14.70
M120630-C	30	79.0	34.0	39.8	35.0	360	€16.30
M120632-C	32	79.0	34.0	41.3	36.5	380	€16.30
M120636-C	36	79.0	34.0	46.0	41.0	390	€19.00

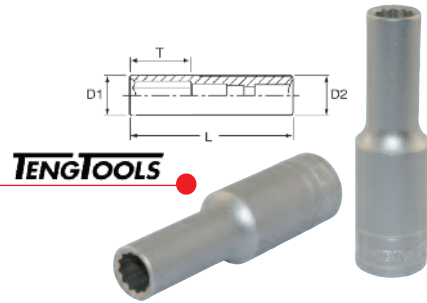

1/2" drive hex S2 socket bits DIN 7422 Chrome vanadium. Satin Finish.

Stock no.	Size mm	L1 mm	L2 mm	D mm	Weight g	Price
M121505-C	5	55.0	20.5	22.0	52	€7.20
M121506-C	6	55.0	20.5	22.0	54	€7.20
M121507-C	7	55.0	20.5	22.0	60	€7.20
M121508-C	8	55.0	20.5	22.0	62	€7.20
M121509-C	9	55.0	20.5	22.0	66	€7.20
M121510-C	10	55.0	20.5	22.0	72	€7.20
M121512-C	12	55.0	20.5	22.0	80	€7.90
M121514-C	14	55.0	20.5	22.0	96	€9.30
M121517-C	17	55.0	20.5	25.0	154	€11.40

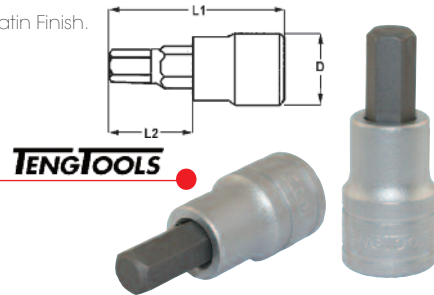

1/2" drive long hex S2 socket bits DIN 7422 Chrome vanadium. Satin Finish.

Stock no.	Size mm	L1 mm	L2 mm	D mm	Weight g	Price
M122505-C	5	100.0	65.5	22.0	60	€7.40
M122506-C	6	100.0	65.5	22.0	60	€7.40
M122507-C	7	100.0	65.5	22.0	80	€7.40
M122508-C	8	100.0	65.5	22.0	80	€7.40
M122510-C	10	100.0	65.5	22.0	100	€7.40
M122512-C	12	100.0	65.5	22.0	120	€9.00

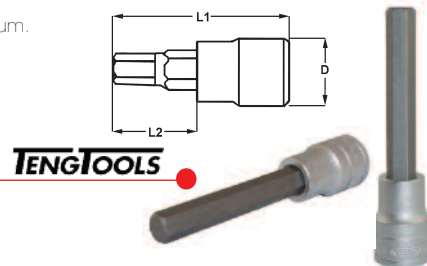

1/2" drive 100mm long Spline socket bits. Chrome vanadium. Satin Finish.

Stock no.	Size	L1 mm	L2 mm	D mm	Weight g	Price
M122805-C	05	100	65.0	22.0	70	€10.30
M122806-C	06	100	65.0	22.0	70	€10.30
M122808-C	08	100	65.0	22.0	70	€10.30
M122810-C	10	100	65.0	22.0	90	€12.40
M122812-C	12	100	65.0	22.0	110	€13.90
M122814-C	14	100	65.0	22.0	130	€15.00
M122816-C	16	100	65.0	22.0	160	€16.50

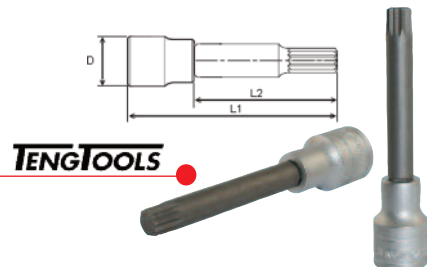



Sockets & Accessories

1/2" Drive Sockets

1/2" drive long Ribbe socket bits. Chrome vanadium. Satin Finish.

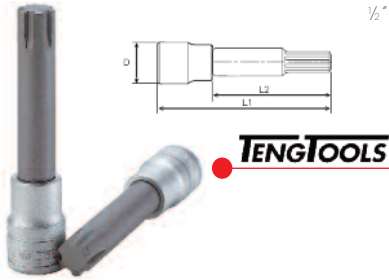

Stock no.	Size mm	L1 mm	L2 mm	D mm	Weight g	Price
M122704-C	04	100	65.0	22.0	70	€10.30
M122705-C	05	100	65.0	22.0	70	€10.30
M122706-C	06	06	100	65.0	22.0	€10.30
M122708-C	08	100	65.0	22.0	70	€10.30
M122710-C	10	100	65.0	22.0	90	€12.40
M122711-C	11	100	65.0	22.0	100	€13.90
M122712-C	12	100	65.0	22.0	110	€16.50
M122713-C	13	100	65.0	22.0	120	€17.40

1/2" drive TPX socket bits. Chrome vanadium. Satin finish.

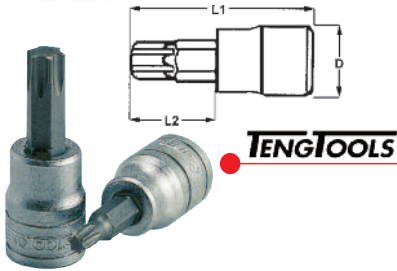

Stock No.	Size	Size mm	L1 mm	L2 mm	D mm	Weight g	Price
M121220-C	TX20	3.5	55.0	20.5	22.0	60	€7.20
M121225-C	TX25	4.5	55.0	20.5	22.0	60	€7.20
M121227-C	TX27	5.0	55.0	20.5	22.0	60	€7.20
M121230-C	TX30	5.5	55.0	20.5	22.0	60	€7.20
M121240-C	TX40	6.5	55.0	20.5	22.0	68	€7.20
M121245-C	TX45	7.5	55.0	20.5	22.0	68	€7.50
M121250-C	TX50	8.8	55.0	20.5	22.0	68	€7.50
M121255-C	TX55	11.1	55.0	20.5	22.0	68	€8.20
M121260-C	TX60	13.1	55.0	20.5	22.0	68	€8.60

1/2" drive TX socket bits. Chrome vanadium. Satin Finish.

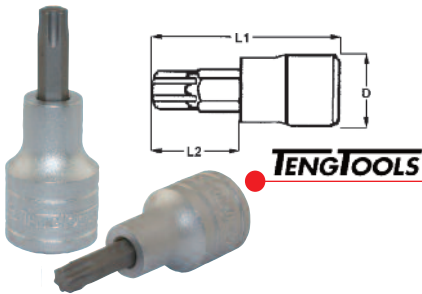

Stock no.	Size	Size mm	L1 mm	L2 mm	D mm	Weight g	Price
M121220T-C	TX20	3.5	55.0	20.5	22.0	60	€7.20
M121225T-C	TX25	4.5	55.0	20.5	22.0	60	€7.20
M121227T-C	TX27	5.0	55.0	20.5	22.0	60	€7.20
M121230T-C	TX30	5.5	55.0	20.5	22.0	60	€7.20
M121240T-C	TX40	6.5	55.0	20.5	22.0	60	€7.20
M121245T-C	TX45	7.5	55.0	20.5	22.0	68	€7.50
M121250T-C	TX50	8.8	55.0	20.5	22.0	68	€7.50
M121255T-C	TX55	11.1	55.0	20.5	22.0	68	€8.20
M121260T-C	TX60	13.1	55.0	20.5	22.0	68	€8.60

1/2" drive 100mm long TX S2 socket bits. Chrome vanadium. Satin Finish.

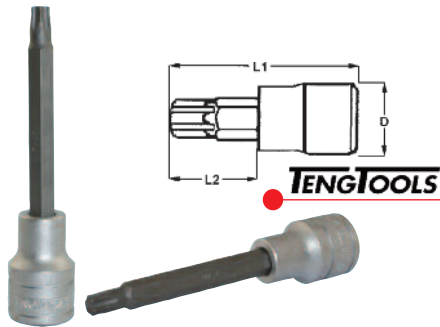

Stock no.	Size	Size mm	L1 mm	L2 mm	D mm	Weight g	Price
M122220T-C	TX20	3.5	100.0	65.5	22.0	60	€11.00
M122225T-C	TX25	4.5	100.0	65.5	22.0	60	€11.00
M122227T-C	TX27	5.0	100.0	65.5	22.0	60	€11.00
M122230T-C	TX30	5.5	100.0	65.5	22.0	60	€11.00
M122240T-C	TX40	6.5	100.0	65.5	22.0	60	€11.00
M122245T-C	TX45	7.5	100.0	65.5	22.0	80	€11.70
M122250T-C	TX50	8.8	100.0	65.5	22.0	100	€11.70
M122255T-C	TX55	11.1	100.0	65.5	22.0	100	€13.40
M122260T-C	TX60	13.1	100.0	65.5	22.0	100	€14.40
M122270T-C	TX70	15.5	100.0	65.5	22.0	100	€15.00

1/2" drive TX-E sockets. Chrome vanadium. Satin Finish.

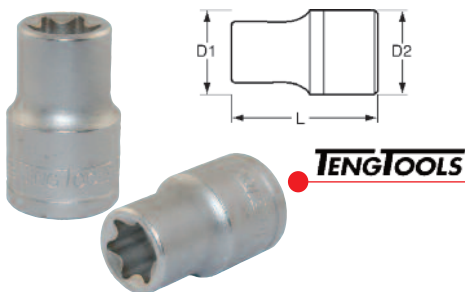

Stock no.	Size	Size mm	L mm	T mm	D1 mm	D2 mm	Weight g	Price
M120710-C	E10	9.3	37.8	9.5	13.1	23.5	39	€7.20
M120711-C	E11	9.7	37.8	9.5	14.1	23.5	42	€7.20
M120712-C	E12	10.8	37.8	9.5	14.9	23.5	43	€7.20
M120714-C	E14	12.8	37.8	12.3	16.7	23.5	44	€7.20
M120716-C	E16	14.6	37.8	13.0	19.1	23.5	49	€7.20
M120718-C	E18	16.6	37.8	13.0	20.9	23.5	52	€7.20
M120720-C	E20	18.4	37.8	13.0	23.7	23.5	60	€7.90
M120722-C	E22	20.3	37.8	16.1	26.1	26.1	82	€7.90
M120724-C	E24	21.9	37.8	16.4	28.0	28.0	102	€7.90



Teng Tools safety locking mechanism

$\frac{3}{4}$ " drive sockets can be heavy and if they drop from the ratchet or an extension bar or accessory it can be a health and safety risk. To reduce the likelihood of this happening Teng Tools have introduced a range of $\frac{3}{4}$ " drive extension bars, a sliding T bar and a universal joint with a safety locking mechanism. This is a simple design which effectively locks the socket in place to prevent it falling off under its own weight. The safety locking accessories are available individually or as part of a 23 piece socket set in a Mecca Rosso carrying case. One more example of how Teng Tools works to create user friendly tools.

$\frac{3}{4}$ " Drive Sockets $\frac{3}{4}$ " drive sockets regular 6 point metric. Chrome vanadium. Satin Finish.

Stock no.	Size	L mm	T mm	D1 mm	D2 mm	Weight g	Price
M3405196-C	19	50.0	14	29.2	33	180	€10.70
M3405216-C	21	50.0	14	31.2	33	180	€10.70
M3405226-C	22	50.0	14	32.2	36	220	€10.70
M3405246-C	24	51.0	16	34.2	36	230	€10.70
M3405266-C	26	52.0	18	36.0	36	240	€11.00
M3405276-C	27	52.0	22	38.0	36	240	€11.60
M3405306-C	30	54.0	24	42.0	38	260	€12.40
M3405326-C	32	56.0	26	44.0	38	310	€13.20
M3405336-C	33	56.0	26	46.0	38	330	€14.50
M3405346-C	34	56.0	26	47.0	38	350	€14.90
M3405366-C	36	58.0	28	50.0	38	430	€15.30
M3405386-C	38	60.0	28	52.0	42	500	€17.30
M3405416-C	41	64.0	30	56.0	45	570	€18.50
M3405466-C	46	68.0	34	62.0	45	690	€22.30
M3405506-C	50	72.0	36	68.0	48	830	€25.00

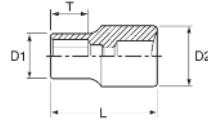

TENGTTOOLS



$\frac{3}{4}$ " drive sockets regular 12 point AF. Chrome vanadium. Satin Finish.

Stock no.	Size AF	L mm	T mm	D1 mm	D2 mm	Weight	Price
M340124-C	$\frac{3}{4}$ "	50.0	14.0	29.2	33.0	180	€11.00
M340128-C	$\frac{7}{8}$ "	51.0	18.1	32.2	36.2	195	€11.00
M340130-C	$\frac{5}{16}$ "	51.0	18.1	34.5	36.2	200	€11.00
M340132-C	1"	51.0	24.0	37.0	37.0	200	€11.00
M340134-C	1 $\frac{1}{16}$ "	51.0	24.0	38.3	37.0	200	€11.00
M340136-C	1 $\frac{1}{8}$ "	51.0	24.3	40.0	38.5	230	€12.10
M340138-C	1 $\frac{3}{16}$ "	53.0	25.2	42.0	38.5	255	€12.10
M340140-C	1 $\frac{1}{4}$ "	55.0	28.0	44.0	38.5	275	€12.50
M340142-C	1 $\frac{5}{16}$ "	55.0	28.0	46.0	38.5	300	€12.50
M340144-C	1 $\frac{3}{8}$ "	57.0	29.7	48.0	42.3	360	€18.30
M340146-C	1 $\frac{7}{16}$ "	57.0	29.7	50.0	42.3	380	€18.30
M340148-C	1 $\frac{1}{2}$ "	60.0	31.1	52.1	45.2	440	€18.30
M340152-C	1 $\frac{9}{16}$ "	63.0	33.7	56.1	45.2	515	€20.00
M340156-C	1 $\frac{3}{4}$ "	65.0	33.7	60.0	48.0	610	€21.70
M340158-C	1 $\frac{5}{8}$ "	67.0	35.7	62.0	48.0	635	€23.10
M340160-C	1 $\frac{7}{8}$ "	69.0	37.2	64.0	48.3	690	€24.00
M340164-C	2"	71.0	38.6	68.2	48.3	755	€24.00

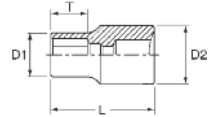

TENGTTOOLS



$\frac{3}{4}$ " drive socket regular. WW. Chrome vanadium. Satin Finish.

Stock no.	Size WW	L mm	T mm	D1 mm	D2 mm	Weight g	Price
M340424-C	ww	56.0	26.2	46.0	38.1	313	€7.90

TENGTTOOLS

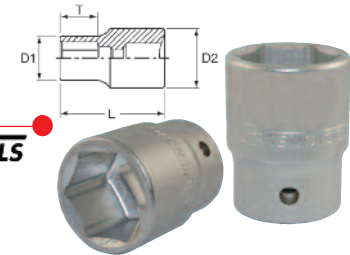

1" Drive Sockets

1" drive sockets regular 12 point metric. Chrome vanadium. Satin Finish.

Stock no.	Size mm	L mm	T mm	D1 mm	D2 mm	Weight g	Price
M110536	36	65.3	31.2	51.0	45.2	440	€26.30
M110541	41	70.2	33.8	57.1	45.2	550	€28.30
M110546	46	74.5	37.5	64.6	49.4	810	€37.00
M110550	50	75.3	38.1	69.9	55.2	995	€41.70
M110555	55	80.0	40.0	76.2	57.3	1160	€44.60
M110558	58	80.0	40.0	79.2	57.3	1250	€44.60
M110560	60	84.0	41.0	82.1	57.3	1410	€48.30
M110565	65	87.3	46.2	88.0	57.3	1540	€64.10
M110570	70	93.4	51.5	94.0	68.1	2020	€71.60
M110575	75	96.1	51.5	94.0	68.1	2020	€78.20
M110580	80	103.6	55.3	105.0	68.1	2500	€92.60

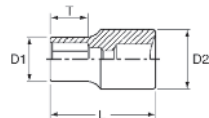

TENGTTOOLS

