



**Sykes-Pickavant**<sup>®</sup>  
*Workshop Solutions*

# SPECIAL OFFERS



# NEW PRODUCTS

**JULY - SEPTEMBER 2012**



[www.sykes-pickavant.com](http://www.sykes-pickavant.com)



## SP MV8000

### Selectline Automotive Tune-Up and Brake Bleeding Kit

- Ideal for Brake Bleeding and basic diagnostic checks requiring vacuum
- Lightweight, non-corrosive and chemical resistant pump
- **Kit Contents :**
  - Selectline PVC Hand Vacuum Pump
  - 135ml Fluid Reservoir with transfer lid
  - Selection of bleed screw adaptors & manifold plugs
  - Tubing and Tube Connectors

**OFFER €94.43**  
**SAVE €26.39**  
 LIST PRICE €120.83



## SP MV7300

### Mityvac PneumatiVac Fluid Evacuator

- Operates on compressed air to create a powerful vacuum for draining fluids
- 9ltr capacity reservoir with stabiliser base
- Automatic shut-off prevents accidental over filling
- Compressed air connection on base for stability, with independent air shut-off valve
- Supplied with evacuation / dipstick tubes and adaptors
  - 1.5mtr x 5.7mm diameter
  - 1.5mtr x 6.6mm diameter
  - 1.5mtr x 10mm diameter

Also supplied with MV7205 accessory kit for vacuum bleeding of hydraulic brake and clutch systems

**€219.95**



## SP MV8550

### Mityvac Silverline Elite Automotive Kit

- Ideal for a wide variety of workshop tasks requiring Vacuum and / or Pressure
- Dual convertor to switch from Vacuum to Pressure
- **Kit Contents:**
  - Silverline Die-Cast Aluminium Vacuum and Pressure Pump to 4bar (60psi) pressure
  - NEW large 480ml Fluid Reservoir with quick connection to pump
  - Selection of 12 vacuum caps
  - Diagnostic / Brake Bleeding Adaptor kit
  - Tubing and Tube Connectors

**OFFER €134.93**  
**SAVE €39.89**  
 LIST PRICE €174.83



## SP 01391000

### Vacuum & Pressure Pump Kit

- A complete test kit for a variety of automotive Vacuum and Pressure related tasks
- Hand Pump generates Vacuum or Pressure
- Supplied with accessories for:
  - Vacuum & Pressure system testing
  - Brake Bleeding
  - Fluid Siphoning

**OFFER €94.43**  
**SAVE €31.79**  
 LIST PRICE €126.23



## SP MV6020

### Mityvac Turbo Pressure Tester Gauge

- From -1Bar to +3Bar
- To be used in conjunction with Mityvac pump MV8550 (quick connection) above
- Allows the user to measure the maximum pressure of the turbo during a road test
- Features a red needle that indicates the maximum pressure reached during the operation

**NEW**



**€128.25**

**sp MV6400**

**NEW**

**Mityvac Fluid Dispensing System**

- Designed for topping-off fluid reservoirs including master cylinders, gear boxes, transmissions, power steering reservoirs, etc
- Large (5-litre) fluid capacity and 5' long hose with dispensing wand and flow control valve make it ideal for accessing hard-to-reach reservoirs and fill plugs
- For transmission refill and pressure bleeding applications, the MV6400 is compatible with a Mityvac ATF and pressure bleed adaptors
- Fluid is dispensed under pressure for smooth continual flow
- Integrated manual pump adds air above the fluid level to prevent aeration
- Internal pump components are sealed against exposure to fluids
- ON/OFF and flow control valve are conveniently located near fluid output



**€249.75**

**sp MV6403**

**NEW**

**Mityvac Fluid Dispensing 3 in 1 Kit**

- A complete package for Automotive Fluid Dispensing
- **Contains:**
  - MV6400 Fluid Dispensing System
  - MV5800 ATF Refill Adaptors Set
  - MVA804 Brake Fluid Master Cylinder Cap Adaptor



To watch a video of the Mityvac Fluid Dispensing 3 in 1 kit, scan the QR Code

**€438.75**



**sp MV7201**

**Mityvac Fluid Evacuator Plus**

- For fluid evacuation AND dispensing
- Change from evacuation to dispensing at the press of a button
- 9ltr capacity reservoir with stabiliser base
- Automatic shut-off prevents accidental over filling
- Manual pump for mobility – no air or electric supply required
- Supplied with evacuation / dipstick tubes and adaptors
  - 1.5mtr x 5.7mm diameter
  - 1.5mtr x 6.6mm diameter
  - 1.5mtr x 10mm diameter



**€189.00**



**sp MV7216**

**Mityvac ATF Transmission Refill Kit**

- Set of 10 adaptors for topping up sealed transmissions when fluid level is low
  - BMW, Ford, Honda, Mercedes, Nissan, Toyota, VAG
- Quick-connect coupler system with ball valve control
  - Use with Mityvac MV7201 Fluid Evacuator Plus (left) or MV6400 Fluid Dispensing System (above)



**€295.00**

**sp 03440000**

**DX2.5 Vacuum Brake Bleeder and Fluid Extractor**

- Includes PVC hose fitted with a universal bleed adaptor, a suction probe and an evacuation hose
- Ergonomically designed handle
  - Turn one way for vacuum mode (for bleeding / extracting)
  - Turn the other way and press activation button for pressure mode (for emptying)
  - Built-in silencer guards against excessive noise levels (below 80 dB)
  - Dual safety features in the handle prevent over-pressurisation in the canister
- Vacuum pre-charge function
  - Allows DX to be used remotely without being attached to air compressor



**OFFER €229.75**  
**SAVE €74.00**  
**LIST PRICE €303.75**

## SP 080500V2

### 4 Way Ball Joint Separator - Car / LCV

- Unique 4-way lever design allows for a wide variety of applications
- 4 options are available, by removing the pin and selecting any of the 4 positions
- Tapered, slim jaw fork design
- 4 position, reversible lever for a wider range of application options
- Tough black epoxy coating

#### Specification:

Jaw opening - 24 / 30 / 40 / 45mm options

Jaw throat width - 19mm

Jaw throat depth - 30mm



**OFFER €59.95**  
**SAVE €16.66**  
**LIST PRICE €76.61**

## SP 66055000

### Ball Joint Separator - Car / LCV

#### Specification:

Jaw opening - 45mm

Jaw Throat width - 19mm

Jaw Throat depth - 30mm



**OFFER €29.95**  
**SAVE €12.24**  
**LIST PRICE €42.19**

## SP 08060000

### Long Reach Ball Joint Splitter

- Long reach professional tool, ideal for ease of access, without being restricted by wheel arches

#### Specification:

Length - 420mm

Jaw throat width - 18mm

Jaw throat depth - 68mm



**OFFER €24.95**  
**SAVE €18.93**  
**LIST PRICE €43.88**

## SP 08730200

### Ford Focus Rear Wishbone Bush Tool

- For removal and installation of rear wishbone / trailing arm bush on all Ford Focus models 1998 onwards



**OFFER €249.95**  
**SAVE €74.05**  
**LIST PRICE €324.00**

## SP 08730300

### Ford Fiesta Rear Bush Tool

- For removal and installation of rear axle mounting bushes as used on Ford Fiesta, Ka and Puma models: 1996 onwards without the need to remove the trailing link assembly from the vehicle

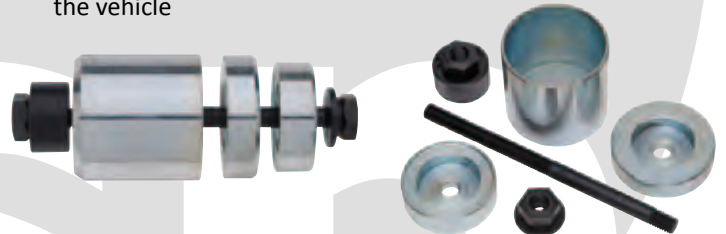

**OFFER €119.95**  
**SAVE €42.05**  
**LIST PRICE €162.00**

## SP 08760100

### VW / Audi Rear Axle Bush Insertion Tool

- For the installation of bonded rubber / plastic type rear axle mounting bushes on: Audi A3 / VW Golf 4 / VW Bora - all models 2001 - 2004
- N.B. - Most models were originally fitted with hydraulic type rubber bushes when new - these can be knocked out manually. This tool is required for fitting the new bonded rubber / plastic type replacement bushes
- Always replace in pairs

**OFFER €129.95**  
**SAVE €42.18**  
**LIST PRICE €172.13**

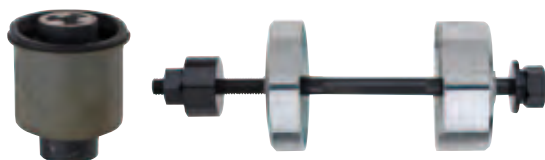

## SP 08760200

### VW Polo Front Control Arm Bush Tool

- For removal and installation of the rear bush on the front control arm, as fitted on VW Polo 11/2001 onwards / Seat Cordoba 11/2002 onwards / Skoda Fabia 12/1999 onwards - all models

**OFFER €179.95**  
**SAVE €52.25**  
**LIST PRICE €232.20**



# SUSPENSION

**SP 08485000**

## Hub Clamp Spreader Tool

- Spreads the steering knuckle to enable removal and fitting of shock absorbers without risk of damage to the knuckle
- Adjustable for use with knuckles which have either a centralised, or non - centralised slot
- Suitable for use on **both single and twin** knuckles
  - **Single knuckles** as found on a wide range of vehicles
  - **Twin knuckles** as found on modern VAG vehicles

**OFFER €64.95**  
**SAVE €34.28**  
LIST PRICE €99.23

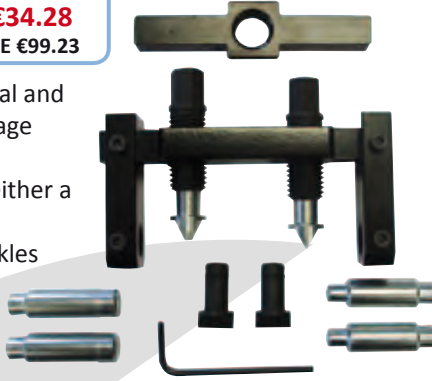

To watch a video of the McPherson Strut Lifter, scan the QR Code

**OFFER €279.95**  
**SAVE €69.70**  
LIST PRICE €349.65

\*Transmission Jack not included

**SP 08487500**

## Strut Controller

- A true 'problem solver' for the disassembly and re-assembly of the internal rebound springs of shock absorbers in suspension struts
- Allows for the safe retaining of the piston rod in extended position
- Universal protective clamp holds piston rod in-situ
- Telescopic handle and bearing assembly allows for correct assembly of new piston
- Universal tool suitable for most vehicle makes:
  - BMW, Fiat, Ford, Mercedes, Nissan, Peugeot, Toyota etc

**OFFER €349.95**  
**SAVE €88.80**  
LIST PRICE €438.75



**SP 08480000**

## McPherson Strut Lifter

- Mounts onto the top of a standard hydraulic transmission jack
- Sleeve available for fitting 24mm transmission jack sizes
- Adjustable top frame allows for secure fixing onto the strut to be lifted
- Tool is left and right handed allowing easy mounting and adjustments in size to fit various sized vehicle requirements

**SP 08487600**

## Universal Protective Clamp for Strut Insert Pistons

- Fixes the piston rod in position when replacing coil springs

**OFFER €84.95**  
**SAVE €22.38**  
LIST PRICE €107.33

**SP 08080000**

## Universal Suspension Arm Lever

- For lowering of the suspension arms and separation of suspension components
- Reduced effort required, due to unique design using leverage and body weight
- Adjustable swing point allows for variable LH & RH applications

**OFFER €219.95**  
**SAVE €48.70**  
LIST PRICE €268.65

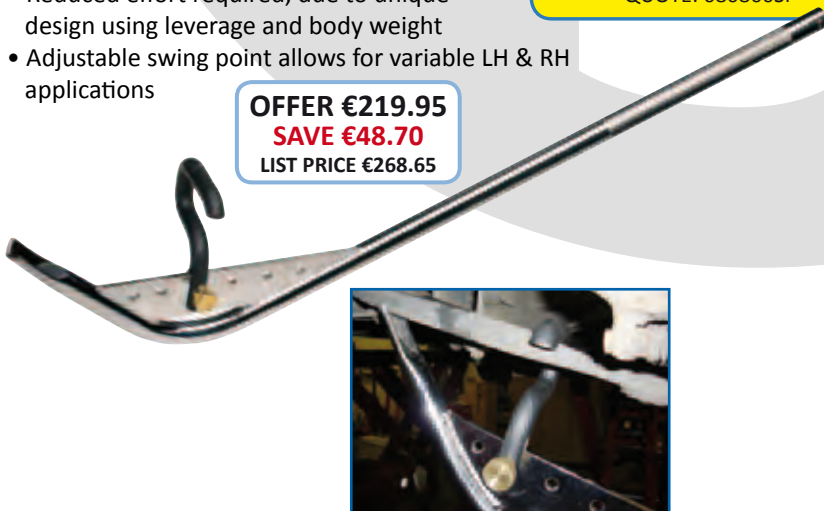

**COMBINED DEAL!**  
BUY 08080000 & 08085000  
TOGETHER FOR A SPECIAL OFFER  
PRICE OF **€239.90** SAVE **€40.00**  
QUOTE: 080800SP

**SP 08085000**

## Suspension Wear Indicator

- An innovative tool for detecting suspension and axle joint wear
- For detecting faults in:
  - Wheel bearings
  - Steering gear and links
  - Stabilizers, bushes and ball-joints
  - Suspension joints and suspension struts
- The tool creates a rocking motion in any direction (forward angle, side angle etc) in order to detect movement in steering and suspension components

**OFFER €59.95**  
**SAVE €34.48**  
LIST PRICE €94.43

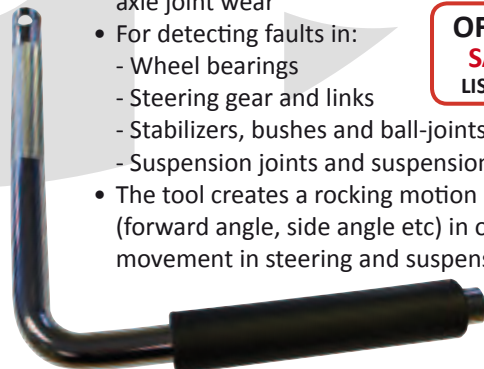

To watch a video of the Suspension Wear Indicator, scan the QR Code



**SP 12730600**

## Hydraulic & Mechanical Hub Puller Kit

Variable Stud Hydraulic Hub Puller Kit, c/w Impact Screw & 5 Legs  
Can be used on a variety of wheel stud pattern applications

- 4, 5, 6 stud hubs, with pitch circle up to 203mm
- 1500 Series Hydraulic Power Ram allows for smooth, progressive application of up to 8 tonnes of force
- Fine pitch thread for easy adjustment
- Floating plunger with free moving legs, enables quick and easy attachment to vehicle hubs
- Can be used in 3, 4 or 5 leg combinations
- Heavy duty force screw with impact handle included, where shock action is required to 'break' stubborn hubs



**OFFER €249.95**  
**SAVE €77.43**  
LIST PRICE €327.38

**SP 18500000**

## Hydraulic Hub Puller

- Universal hydraulic hub puller, uses power from the SP1500 series ram (8 tonnes)
- Compatible with 3, 4, 5 & 6 stud wheel hubs
- Supplied with threaded studs / extended nuts to cover five popular thread patterns
  - 3 x stud pattern threads
  - 2 x extended nut pattern threads
- Colour coding of studs / extended nuts makes for easy identification and component selection
- Can be used with the following thread forms:
  - M12 x 1.25 studs
  - M12 x 1.5 studs
  - M14 x 1.5 studs
  - M12 x 1.25 extended nuts
  - M12 x 1.5 extended nuts
- Vehicle model / stud pattern applications chart provided

**OFFER €349.95**  
**SAVE €115.80**  
LIST PRICE €465.75



**SP 18550000**

## LCV Impact Hub Puller

- To fit 5 and 6 stud hubs on LCV hubs with a pitch circle of 90-170mm
- Six sets of Male & Female connector rods
- M12 x 1.25 / M14 x 1.5 / M16 x 1.5 Male Rods
- M12 x 1.5 / M14 x 2.0 / M18 x 1.5 Female Rods

### Applications:

- Citroen Jumpy / Dispatch / Jumper / Relay
- Ford Transit
- Fiat Ducato
- Iveco Daily 11 / 111
- LDV Maxus
- Mercedes Sprinter / Vito
- Nissan Primastar
- Opel Movano / Vivaro
- Peugeot Boxer / Expert
- Renault, Master / Trafic
- VW LT / Transporter

Supplied with Heavy Duty 4.3kg Slide Hammer  
LCV vehicle applications list included

**OFFER €349.95**  
**SAVE €88.80**  
LIST PRICE €438.75



**SP 08531600**

## Hydraulic Hub Puller

- Specially designed extra-wide hub puller plate
- Includes hydraulic ram c/w nose piece

**OFFER €129.95**  
**SAVE €38.80**  
LIST PRICE €168.75



**SP 08530000**

## Mechanical Hub Puller

- Consists of hub puller plate, Mechanical screw - 5/8" UNF x 140mm x 24mm hex

**OFFER €79.95**  
**SAVE €27.38**  
LIST PRICE €107.33



**SP 08530600**

## Slide Hammer Hub Puller

- Specially designed hub puller plate
- Extra wide spread up to 175mm stud circle spread
- Includes Slide Hammer - 5/8" UNF x 1.6kg

**OFFER €129.95**  
**SAVE €54.33**  
LIST PRICE €184.28



**SP OTC6575**

**NEW**

**OFFER €776.25**  
**SAVE €135.00**  
 LIST PRICE €911.25

## Hub Grappler

Apply maximum force with minimum effort!

The OTC Hub Grappler Kit is the complete solution for servicing wheel hubs and bearings on the vehicle without removing the steering components or knuckle. Eliminates the use of a workshop press, cutting service time dramatically.

- The new Hub Grappler Puller is specifically designed to apply maximum force with minimal effort from an impact gun
- Jaws are designed and shaped to properly fit hub applications and can be quickly positioned on the puller beam
- Custom drive screw coupled with thrust bearing and washer provides smooth operation – safe for impact gun use
- Includes Hub Grappler Application Guide –
  - Comprehensive application guide includes diagrams and instructions showing how and where every adaptor is used
- Application Chart references front/rear, hub/bearing removal and installation adaptor part numbers
  - Based on vehicle make, model, and year
- Application Diagrams show puller and adaptors properly mounted on steering knuckle



To watch a video of the Hub Grappler, scan the QR Code



**SP 21200000**

## 20 Tonne Loadstar 'Plus' Press Frame Complete Kit

Stand alone portable press frame kit for extracting (pushing) operations



**OFFER €2558.25**  
**SAVE €411.75**  
 LIST PRICE €2970.00

**SP 08797500**

## Universal Press & Pull Sleeve Set - Commercial Vehicle Kit

For the Removal and Installation of Bushes, Bearings, Seals etc

- Complete kit for SUV / LCV / PSV / HGV
- Includes 20 x Press Sleeves in 2mm diameter steps
  - Inside diameter from 74 - 112mm in 2mm steps
  - Outside diameter from 84 - 122mm in 2mm steps
- 4 x Pulling Spindles with Nuts and Thrust Bearings
  - M10 / M12 / M14 / M16
- 2 x 20mm Heavy Duty Pulling Spindle Adaptors with Thrust Bearings
  - M20
- 4 x Step Plate Discs:
  - Disc 1 / Disc 2 / Disc 3 / Disc 4

**OFFER €1343.25**  
**SAVE €540.00**  
 LIST PRICE €1883.25



Heavy Duty Pulling Spindles



**SP 21205000**

## 20 Tonne Loadstar 'Plus' Press Frame Complete Kit - Special Version for "Optare" Buses

As per 21200000 (above) with additional pushing pin for Optare applications

**OFFER €2693.25**  
**SAVE €405.00**  
 LIST PRICE €3098.25



**SP 21201000**

## 20 Tonne Loadstar 'Plus' Press Frame Kit

As per 21200000 (above) minus Hydraulic Pump

- Uses standard 10,000psi pump with 3/4" Connector

**OFFER €2153.25**  
**SAVE €364.50**  
 LIST PRICE €2517.75



## Motorq Professional Torque Wrench Range

### Features include:

- Secure locking mechanism to avoid forced adjustment against the lock
- Extended handle for comfort and reduced calibration drift
- Ideal for both LH & RH applications
- Dual scale - Nm / lbf.ft
- Chemical resistant lens for clear reading of scale
- Accurate to + / - 3%, manufactured to ISO6789 standard
- Supplied in moulded storage case with calibration certificate, traceable to National Standards



Part No.	Description	Range Nm	Range lbf.ft	Length	Weight	List Price	Offer Price
80002000	3/8" Push-Thru Square Drive	4 - 20	3 - 15	210mm	0.40kg	€123.19	€89.95
80006000	3/8" Push-Thru - 72 tooth ratchet & case	8 - 60	6 - 45	305mm	0.60kg	€164.03	€119.95
80010000	3/8" Push-Thru - 72 tooth ratchet & case	20 - 100	15 - 74	356mm	0.75kg	€164.03	€119.95
80020000	1/2" Push-Thru - 72 tooth ratchet & case	40 - 200	30 - 148	455mm	1.00kg	€187.31	€139.95
80030000	1/2" Push-Thru - 60 tooth ratchet & case	60 - 300	44 - 221	570mm	1.40kg	€205.88	€149.95
80033000	1/2" Push-Thru - 60 tooth ratchet & case	60 - 330	44 - 243	690mm	1.40kg	€226.13	€169.95
80039900	3/4" Push-Thru Square Drive	80 - 400	59 - 295	690mm	2.10kg	€319.28	€239.95

## Digital torque angle adaptors turn power bars or ratchets into a torque wrench Combines torque and angle measurement

Angle Range: 5-360° | Angle Accuracy: +/- 1% | Battery Life: 110 hours | Torque Overload Alarm  
Selectable units of measurement: Kg-m | Nm | Lbft

Supplied in moulded storage case with calibration certificate



**80091500**

### Torque Angle Adaptor 27 – 135Nm – 3/8 sq dr

- Torque range 27-135Nm
- Torque accuracy +/- 2%

**OFFER €159.95**  
**SAVE €41.88**  
LIST PRICE €201.83

**80092500**

### Torque Angle Adaptor 40 – 200Nm – 1/2 sq dr

- Torque range 40-200Nm
- Torque accuracy +/- 2%

**OFFER €159.95**  
**SAVE €41.88**  
LIST PRICE €201.83



**80070000**

### 'Motorq 700' Angular Torque Gauge 1/2" sq dr

- For turning torqued fasteners through a further angle, as per vehicle manufacturers' specifications
- Oil resistant, non-reflective surface and adjustable reaction arm
- Supplied with both male and female square drives



**OFFER €44.95**  
**SAVE €17.83**  
LIST PRICE €62.78



## 'Motorq' Heavy Duty Torque Multipliers

### Features include:

- Single stage epicyclic gears, producing a 5:1 multiplication ratio
- Use with conventional torque wrenches for heavy duty applications
- Supplied with reaction bars, in plastic storage case



Part No.	Ratio	Input Drive	Max. Input	Output Drive	Output Range	Weight	List Price	Offer Price
80060000	5:1	1/2" sq.dr. / 32mm hex	260Nm	3/4"	130 - 1300Nm	4.3kg	€1059.75	€779.95
80065500	5:1	3/4" sq.dr. / 36mm hex	540Nm	1"	270 - 2700Nm	4.5kg	€1086.75	€799.95



**SP 80075000**

### 'Motorq 750' Angular Torque Gauge 3/4" sq dr

- For turning torqued fasteners through a further angle, as per vehicle manufacturers' specifications
- Oil resistant, non-reflective surface and adjustable reaction arm
- Supplied with both male and female square drives

**OFFER €47.95**

**SAVE €17.53**

**LIST PRICE €65.48**

## 'Motorq' Heavy Duty Torque Wrench Range

### Features include:

- Break-back type of torque wrench for heavy-duty applications
- 36 tooth ratchet head with push-thru square drive
- Graduated scale on handle for easy adjustment
- Supplied with Calibration Certificate, traceable to National Standards



Part No.	Description	Range Nm	Range lbf.ft	Length	Weight	List Price	Offer Price
80040000	3/4" Push-Thru Square Drive	150 - 700	110 - 516	1090mm	6.00kg	€533.25	€399.95
80040200**	3/4" Push-Thru Square Drive	150 - 700	110 - 516	1090mm	6.00kg	€594.00	€469.95
80050000	3/4" Push-Thru Square Drive	300 - 1000	221 - 738	1470mm	7.00kg	€546.75	€419.95
80050200**	3/4" Push-Thru Square Drive	300 - 1000	221 - 738	1470mm	7.00kg	€610.88	€499.95
80055000	1" Push-Thru Square Drive	700 - 1500	500 - 1000	1470mm	10.40kg	€820.13	€619.95

\*\* Models 80040200 / 80050200 supplied with NAMAS / UKAS Laboratory Calibration Certificate

## Keepower Intelligent Battery Care Battery Charging – Battery Boosting

Microprocessor controlled for optimum efficiency  
Suitable for all battery types – AGM / GEL / WET etc  
Spark free technology – protects against overload and short circuits  
Intelligent charging regime – 9 modes of charging



88813400

### Includes:

- 'Testing' phase for general battery condition
- 'Soft Charge' for deep discharged batteries
- 'Boost' phase to kick-start battery with low power
- 'Supply' mode – use the charger as a power supply in order to keep battery fully charged

### Additional Features:

- Flashlight – enables you to clearly see connections
- iPod charger – charge your iPod / Mobile phone via USB connection (XL-Pro only)
- Hook-free clamps – avoids tangled cables
- IP protection rating – suitable for use in damp conditions

**sp 88813400**

### Keepower Large Intelligent Charger - 15A

Nominal Battery Voltage:	12v
Charge Current:	15A
Battery Size:	40Ah - 300Ah
Max. Output Power:	275W
Input Voltage:	230v / 50hz
Protection:	IP44
Charging Cable:	2.5mm x 1.8mtrs
Mains Cable:	2mtrs
Weight:	0.90kg

**OFFER €299.95**  
**SAVE €71.30**  
LIST PRICE €371.25

**sp 88813800**

### Keepower XL-Pro Intelligent Charger - 30A

Nominal Battery Voltage:	12v / 24v
Charge Current:	30A / 15A
Battery Size:	3Ah - 600Ah
Max. Output Power:	525W
Input Voltage:	230v / 50hz
Protection:	IP44
Charging Cable:	4.00mm x 1.8mtrs
Mains Cable:	2mtrs
Weight:	1.36kg

**OFFER €429.95**  
**SAVE €103.30**  
LIST PRICE €533.25

**sp 30077000**

### Professional Data Saver - EOBD

- A professional solution for saving vehicle data – complete unit ready for immediate use
- Saves the on-board computer memory while the vehicle battery is disconnected
  - Diagnostics memory, anti-theft settings, radio presets, electric mirror and comfort settings etc
- EOBD cable for fast connection to the vehicle
  - Cigarette lighter adaptor for non-EOBD and older vehicles
- High capacity, rechargeable, internal 12v sealed lead-acid battery allows for extended use between re-charges – no separate vehicle battery required
  - State of charge indicator identifies when Data Saver needs recharging
- Safety cut-out fuse to protect against excessive current draw

**€129.95**



**NEW**





SP 30076500

**NEW**

## Automotive Relay Tester

- Quickly and accurately test electro-mechanical relays used on most cars both 4 & 5 pin relays
- Performs all required test functions automatically
- Applies a signal to the relay coil and checks for consistent functioning of contacts
- Unit automatically indicates test results with a series of red, green and yellow performance lights
- 9V battery included

**€53.93**

**OFFER €19.95**  
**SAVE €15.83**  
LIST PRICE €35.78

SP 30042400

## Professional Cordless Circuit Tester

- Safe to use with ECM's, Sensors, Transducers, Airbags etc
- No ground wire or clips required
- Detects from 3 to 28 volts
- Light, Sound and Vibration to indicate voltage
- Rugged stainless steel construction
- Unique V-groove needle accessory for wire piercing
- Solid state lamp for longer lasting performance
- Long life alkaline batteries included



SP 30079500

## Multi-Voltage Glow Plug Tester

- The ultimate tool for testing glow plugs
- Works on all types of glow plugs – of any voltage
- 4.4v / 5v / 7v / 8.5v / 10v / 11v.....and more!
- Displays: Open Circuit – Short Circuit
- Also measures actual glow plug resistance for evaluation of the plug specification
- Shrouded high quality leads
- Internal 9v battery and low battery warning
- Auto shut off when not being used
- Oil resistant rubber shroud for protection

**€228.83**



SP 30069500

## Key Fob BIP Tester

- Infra-Red (IR) and High Frequency (HF) remote control tester
- Prevents central locking and alarm faults being diagnosed incorrectly
- Compatible with 315, 433 & 866 MHz remote control frequencies
- Power supply: 9v. Battery (included)



**€99.95**



To watch a video of the Glow Plug Tester scan the QR Code

SP 30042600

## Inteliprobe

Ideal for locating bad earths, breaks in continuity and short circuits quickly & easily

- Intelligent Auto Probe for testing 6v - 24v circuits
  - Energize Components
  - Polarity test
  - Continuity test
- Short Circuit Protection

**€39.95**



SP 30072500

## Digital Diesel Fuel Pressure Meter

- Uses voltage to measure the High Pressure from the common rail pressure sensor
- Converts signal to PSI and BAR
- Pressure Range 0 - 1500 BAR
- Works on 12v supply
- Ideal for making comparative pressure tests against ECU readings and against actual rail pressure

**€168.75**

# THE SP FAMILY OF ELECTRONIC

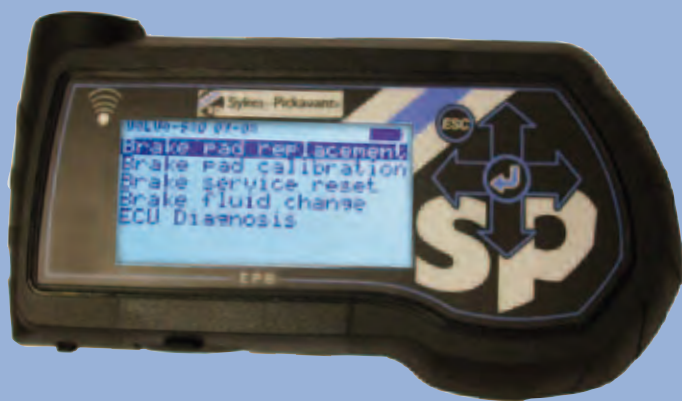

**SP 30662000**

## EPB Service & Reset Tool

An All-Makes Service Tool for electronically controlled Brake Service functions

- Functions included:
  - EPB – brake pad replacement
  - CAL – brake pad calibration
  - Reset – brake service reset
  - Fluid Purge – ECU controlled brake fluid change
- Make & Model search facility
- Read & Clear Error Codes (EPB / ABS / ESP)
- Annual Update available for new models (€165.00)

**€649.95**



**SP 30650000**

## SPe Electronic Service

An invaluable aid for the technician, it includes ALL of the Service & Diagnostic functions

- Access to ALL of the Electronic Systems
- Complete Vehicle Diagnostics
- Reset Engine & Fuel System
- Injector & Control Valve

**€269.00**  
ANNUAL SUBSCRIPTION: €67.00

**SP 30650000**

## SPe Electronic Service

Work with ease on modern vehicles with electronically controlled service functions including:

- Service Light & Service Module Reset
- Engine Systems Check
- Electronic Park Brake & Pad Change

**€1995.00**  
ANNUAL SUBSCRIPTION: €337.50



**NEW 2012 MODEL**

**SP 30670100**

## BluBox - EOBD Advanced Data Recorder

Assists in the diagnosis of intermittent faults, engine management and economic driving parameters

Functions Include:

- Vehicle Management
- Intermittent Fault Analysis
- Eco Drive
- LPG / Natural Gas

**€195.00**

### UPDATES FOR 2012

- Increased range of selectable parameters
- Engine Management fault code information
- Find faults immediately in playback mode
- Store results by individual model or vehicle

Full details for all featured tools can be viewed at: [www.sykes-pickavant.com](http://www.sykes-pickavant.com)

# SERVICE & DIAGNOSTIC TOOLS



**€649.95**

**SP 30661000**

## TPMS TOOL - All-Makes TPMS Tool

### Sensor Activation - Sensor Checking - Sensor Replacement

#### TPMS Features:

- Test feature allows for checking operation of sensors and sensor batteries
- Selects model specific sensors only
- Includes sensor specific technical data
- Built-in sensor checking – no exciter tool required
- Check sensors individually, or full car
- Print and save test reports for your customers
- Investigate and troubleshoot sensor malfunctions
  - E.G. High / Low pressure readings, internal air temperature, damaged sensors etc
- Sensor replacement procedures and data for specific applications
- Annual Update available for new models (€165.00)

**53500**

## Diagnostic Workshop

Diagnostic Technician that  
 & Bodywork functions PLUS:  
 Electronic modules on the vehicle  
 Vehicle ECU scans  
 ABS System Parameters  
 Component Coding

**55.00**  
 ANNUAL SUBSCRIPTION:  
 5.00

**SP 30652500**

## SPe Electronic Bodywork

Assessing accident damage & estimate the cost  
 of repair to vehicle electronic systems including:

- Airbag & ECU Enabling & Coding
- Central Locking / Immobilizer & Anti-Theft Controls
- Steering & Suspension System

**€2195.00**  
 ANNUAL SUBSCRIPTION:  
 €337.50



**SP 30661500**

## TPMS PLUS - All-Makes TPMS Tool

All the features of the standard TPMS Tool  
 (above), PLUS the following additional features:

- Sensor re-programming via the EOBD socket
- Sensor fault code reading / deletion
- System enabling / disabling
- Pressure / Battery condition / Temperature readings
- Summer / Winter tyre set up
- Sensor and ECU testing and pairing procedures
- Annual Subscription Available (€450.00)

**€1295.00**

Full details for all featured tools can be viewed at: [www.sykes-pickavant.com](http://www.sykes-pickavant.com)



## SP 324200SP

### Portable 4 Gas Analyser

- A truly portable hand-held gas analyser
  - Ultra light weight - only 1.1Kg
- Measures CO, HC, CO2, O2 – to class 1 accuracy
  - Suitable for both Petrol and LPG vehicles
- Ideal for both static and dynamic testing
  - Fault diagnosis, tuning, pre-MOT testing
- Provides Lambda / AFR measurement and corrected CO
- Internal memory – stores up to 250 test results
  - Automatic and Manual recording options
- Long battery life – 8 hours between recharges

**INCLUDES  
FREE  
PRINTER &  
SOFTWARE**



**OFFER €1795.00  
SAVE €533.75  
LIST PRICE €2328.75**



### Includes Portable 4 Gas Analyser + Infra Red Printer + FREE AGAR Software (Advanced Gas Analyser Reader)\*\*

- 4 Gas Analyser sends results via an integral IR transmitter to the remote printer
- AGAR Software – runs on your PC / Laptop – enter your Gas Analyser results
  - Provides professional guidance to solve the problem quickly
  - Determines potential faults immediately
  - Internal database of results – create your own library of test data
  - Emission test guideline values for all European vehicles – petrol and diesel
  - EOBD emissions code data
  - Internal encyclopedia of fuel system components and terminology
  - Printed report identifies area of fault and suggested checks

\*\* AGAR software c/w 1 year license including 12 months update



## SP OTC3109

### Autoscanner – OBD11 / EOBD Scan Tool

The next generation of Scan Tool – professional grade scan tool features at a code reader price!

- Suitable for OBD11 (1996-), EOBD (Petrol 2001-), (Diesel 2004-) and Hybrids
- Includes graphing of live engine sensor data in real time
- Ideal for pin-pointing problems and quick diagnosis
- Lightweight hand held unit – only 0.36kg



Live Engine Data



Graphing Live Data



**€139.95**

### OTC3109 - Autoscanner

Compatible with OBD11 & EOBD 1996 -

Read, Display & Clear DTC's

- P, B, C, U codes
- 27,000 Generic & Specific Codes

Live Engine Data

Display & Reset MIL

Display Freeze Frame Data

Display I/M monitor status

Display VIN, CVN, Cal ID

Communication Status

EOBD Emissions State Check

EOBD Drive Cycle Mode

Graphing of Live Data

Multi-Lingual ( 6 languages selection )

**SP OTC6909**

**NEW**

**Oil Filter Socket Set on Magnetic Rail**

Set of 5 Oil Filter Sockets specifically aimed at Asian manufactured models

- 6903 = 75.6mm x 14 flutes – Mazda & Toyota
- 6904 = 88.2mm x 15 flutes – Hyundai & Kia
- 6905 = 66.5mm x 14 flutes – Subaru
- 6906 = 65.0mm x 14 flutes – Toyota
- 6908 = 73.0mm x 14 flutes - Toyota

**€67.43**

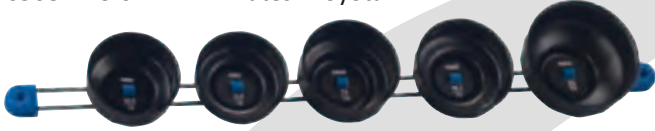

**SP OTC6596**

**NEW**

**Brake Pad Gauge**

SPEED UP your inspection process!

- The Brake Pad Gauge allows for a definitive measurement of brake pad thickness to determine the remaining life of the brake pad
- Unique design allows for measurement on the vehicle without the removal of any components (wheel assembly or brake caliper)
- Quick reference of Brake Pad condition via colour coded micrometer scale



**€20.18**



**SP OTC8206**

**6 Pc. OTC Heavy Duty Pry Bar Set**

- Heavy-duty pry bars made of tempered square steel that you can hit without damaging the handle
- Ergonomic handle – bi-material composite handle for user comfort; reduces hand fatigue
- Polished tip with black oxide long-life finish - resists rust & wear during use
- Set includes: 20cm , 30cm, 45cm, 60cm, 81cm and 90cm bar shank lengths in a moulded storage tray

**€148.50**



**SP OTC4512**

**OTC Internal & External Circlip Pliers Set**

- For internal or external circlips / snap rings; thumbscrew permits quick conversion from internal to external use
- Made of heavy-gauge tempered steel
- Set Contents:
  - 4 x straight tip circlip pliers
  - 4 x 90° tip circlip pliers
  - 1 x straight tip pick
  - 1 x 90° tip pick

**€79.95**

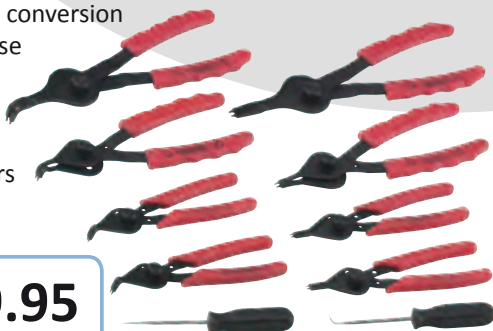

**NEW**

**SP OTC5911**

**Drain Plug Pro™**

Hot Oil in the Pan – NOT on your Hands!

- Removes oil drain plug without touching the plug or hot oil
- Just magnetically attach DRAIN PLUG PRO™ to pre-loosened drain plug and rotate to remove plug
- NO touching HOT plug
- NO HOT oil on hands
- NO dropping of plug in HOT oil
- NO oil soaked gloves



To watch a video of the Drain Plug Pro, scan the QR Code

**€25.58**



**NEW**

**SP OTC4536**

**A/C Clutch Pulley Puller Kit**

For removal of stubborn air conditioning clutch pulleys

- Can also be used on many alternator, power steering and crankshaft pulleys, harmonic balancers and timing gears
- Drop-forged components: Live centre forcing screw, Pulling beam with 3 spread settings, 2 x pair of jaws and Clamping bolt
- Spread: 75 - 125mm Reach: 25 - 125mm

**€128.25**



**SP OTC7402**

**OTC Professional Thread Chaser**

- Quickly restores threads to near original condition without the use of expensive thread-cutting equipment
- Ideal for restoring damaged threads on axles, pins, shafts etc, from 25 – 140mm diameter
- Dies suitable for MM thread pitches: 1.00, 1.25, 1.50, 1.75, 2.00, 2.50, 3.00, 3.50, 4.00mm
- Also includes SAE dies for thread pitches: 4 - 24 tpi

**€134.93**



**€559.95**

**SP 36600500**

## Fuel Extractor / Retriever

Retrieve fuel following a filling error (e.g. petrol instead of diesel, etc.), removal of tank sender unit, changing or checking the fuel gauge, rinsing the fuel tank during body work etc.

- Operates from workshop compressed air (no risk of sparks)
- Mobile 45-litre tank (on wheels)
- Cleanly draws up or pushes out fuel due to a venturi system
- Includes 2 anti-static ground cables, overflow line and 3 fuel probes
- Emptying via the tank filler neck or fuel lines
- Made of stainless steel

**INCLUDES FREE  
PLIERS SET  
WORTH €48.00!**



**3 Pc. Set of Self Locking Pliers**

**Includes**

- Heavy Duty Pliers
- 9" Long Nose
- 8" Engineer
- 7" Side Cutters



**SP MV5600**

**NEW**

## Fuel Retriever Fuel Line Adaptor Set

**€54.95**

- Allows the Fuel Retriever (36600500 - above) to be connected in-line for extracting fuel from fuel lines and pumps
- Connects just before the injection pump (on most fuel lines or filters) for completely safe removal of fuel



**SP 81915**

## 3 Pc. Flex Flare Nut Wrench Set

- Ideal for Brake Bleeding Nipples
- 9x11, 10x12, 13x14

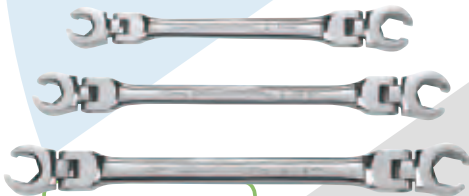

**€44.95**

**SP 34300100**

## Automatic Brake Bleeder - 12v

- Compatible with ABS systems
- 12v powering with reverse polarity warning
- New pump with automatic power off valve
- Regulator from 0 to 3Bar
- 5l reservoir with visible level and min level indication
- Auto power OFF when min level reached
- 12V power cable with jack (L: 4m)
- Fluid cable for brake fluid with quick coupling system (L: 4m)
- Includes fluid collection bottle and European screw-on reservoir cap
- Stainless steel body



**INCLUDES FREE  
VACUUM / PRESSURE KIT  
WORTH €155.00!**

**Includes**

- Dual Vacuum & Pressure Pump
- 480ml Fluid Reservoir
- Selection of caps, tubing & tube connectors

**€749.95**





Space Heaters – Fan Operated – 2.0kW or 3.3kW

- Ideal fan heaters for use in a wide variety of situations:
  - Workshops, garages, storerooms, shops, greenhouses etc
- Manufactured with rugged steel cabinets and strong safety insulated handles
- Encapsulated stainless steel heating elements, insulated from the cabinet housing
- Safety thermostat to prevent overheating
- Selector switch for either half, or full, heating effect
- Infinitely variable room thermostat to ensure desired temperature is maintained
- Can also be used for cold air circulation in warm conditions
- Manufactured in EEC

**NEW**

**sp 88042007**

**Space Heater - Fan Operated 2.0Kw**

**€99.95**



**sp 88043007**

**Space Heater - Fan Operated 3.3Kw**

**€109.95**



	88042007		88043007	
Model	2.0kW		3.3kW	
	HALF HEAT	FULL HEAT	HALF HEAT	FULL HEAT
Output kW	1.0	2.0	1.65	3.3
Output kcal/h	860	1720	1420	2840
Mains Voltage	230		230	
Mains Current	8.7A max		14.3A max	
Fan Diameter	170mm		230mm	
Air Circulation	300 m <sup>3</sup> /h		400 m <sup>3</sup> /h	
Dimensions - mm	230 x 200 x 330		250 x 250 x 420	
Weight	5.0kg		7.5kg	

**sp 03200000**

**Antifreeze & Coolant Hydrometer**

- For testing Ethylene Glycol
- Temp range: -5°C to -40°C



**OFFER €11.95**  
**SAVE €4.18**  
**LIST PRICE €16.13**

**sp 03200200**

**Antifreeze & Coolant Hydrometer**

- For testing Polypropylene Glycol
- Temp range: -5°C to -40°C

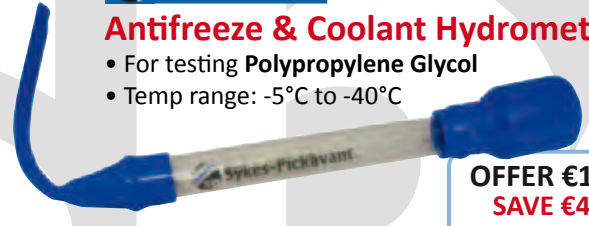

**OFFER €11.95**  
**SAVE €4.18**  
**LIST PRICE €16.13**

**sp 03201000**

**Refractometer - NEW Model - Now with Internal Light**

Tests Coolant, Battery Acid, Screenwash and AdBlue using an optical prism test technique

- Now with NEW internal Light feature for ease of use in poor light
- Coolant - tests both propylene and ethylene based anti-freeze coolant solutions and determines the freezing point
- Battery Acid - indicates the specific gravity of the battery electrolyte
- Screen Wash - shows the freezing point of screenwash fluids in degrees C
- NEW - AdBlue – Indicates % concentration of AdBlue additive

**OFFER €89.95**  
**SAVE €30.88**  
**LIST PRICE €120.83**

**NEW**



Features NEW Internal Light

**SP 02210000**

## Telescopic Pipe Tube Cutter 3 - 32mm

- Telescopic action cutter
- Grooved rollers allow for cutting close-up to flared pipe ends
- Includes fold-away de-burring blade and spare cutter wheel



**OFFER €19.95**  
**SAVE €9.68**  
LIST PRICE €29.63

**SP 02460000**

## Adjustable Pipe Bending Tool for ALL pipe sizes between 4.75 and 10mm

- A unique, fully adjustable tool for forming perfect bends on pipe sizes from 3/16" (4.75mm) to 3/8" (10mm)
- Unique design allows for infinite adjustment capability for all pipe size variations within the overall range
- Hand held operation for in-situ work, and fitted with vice mounting lug for greater control when forming bends



**NEW**



**OFFER €99.95**  
**SAVE €28.30**  
LIST PRICE €128.25

**SP 03570000**

## Brake & Fuel Line Clamp

- Lightweight, non-conductive, glass fibre reinforced nylon clamp
- Useful for when the clamp needs to be left on the brake line for an extended period



**OFFER €9.95**  
**SAVE €2.54**  
LIST PRICE €12.49

**SP 02340000**

## Brake Pipe Corrosion Tool

- Especially designed to allow the user to inspect brake pipes for corrosion, both quickly and easily
- Features two scraper areas on the head of the tool, which allows the user to remove dirt and corrosion from the pipes and thereby be able to effectively examine the condition of the pipes



**OFFER €13.95**  
**SAVE €6.23**  
LIST PRICE €20.18

**SP 66092500**

## Mini Pipe Tube Cutter 3 - 22mm

- One-hand operation, ideal for on-the-vehicle working

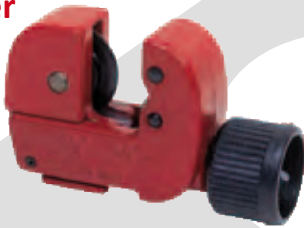

**OFFER €8.95**  
**SAVE €2.53**  
LIST PRICE €11.48

**SP 02560000**

## Pipe Bender

- Pipe Bender for Plastic Coated Pipes: 4.75 - 6mm
- Unique rolling action forms bends up to 180° without causing abrasion damage to plastic or epoxy coated pipes
- Fitted with lug on handle for bench use with a vice
- Pipe sizes:  
- 3/16" to 1/4" - 4.75mm to 6.00mm



**OFFER €54.95**  
**SAVE €10.53**  
LIST PRICE €65.48

**SP 02160000**

## Brake Pipe Aid Pliers

- For forming tight bends in brake and clutch pipes
- Ideal for use in restricted space and for use on-the-vehicle
- Can also be used for quick tube nut thread alignment and as a guide when cutting tube
- For 3/16" or 4.75mm pipe

**OFFER €34.95**  
**SAVE €8.18**  
LIST PRICE €43.13



**SP 02165000**

## Dual Size Brake Pipe Plier

- For forming tight bends in brake pipes
- Ideal for use in restricted space and for use on-the-vehicle
- Dual size - One Tool - Two Pipe sizes
- For 3/16" / 4.75mm & 1/4" / 6.00mm pipes

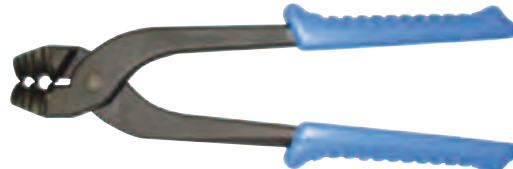

**OFFER €37.95**  
**SAVE €9.23**  
LIST PRICE €47.18

**EXCLUSIVE**  
SP Design

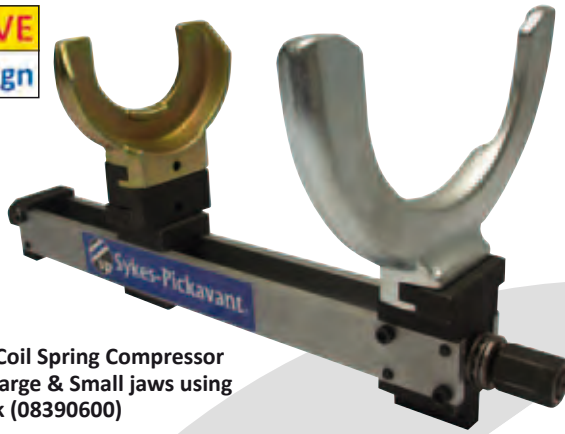

08390000 - Coil Spring Compressor fitted with Large & Small jaws using Spacer Block (08390600)

**SP 08390000**

## Heavy Duty Coil Spring Compressor

Unique Sykes-Pickavant design of vice-mounted Coil Spring Compressor

- Features double-ended hex drive (2 x 24mm hex) for ease of use
  - Can be operated from either end using ratchet or 24mm wrench
- Hex drives at both ends, incorporate shear-pins for safety
  - Features external thrust bearing for ease of service
  - Heat treated, Self-lubricating operating screw
- Safe Working Load = 15000N
- Supplied with two sets of universal jaws:
  - Medium Jaws – 110-150mm dia
  - Large Jaws – 140-195mm dia

**OFFER €499.95**  
**SAVE €133.20**  
LIST PRICE €633.15

**SP 084000SP**

## Heavy Duty Coil Spring Compressor c/w Universal Multi-Purpose Jaws and Safety Cage

- Includes 08400000 - Heavy Duty Coil Spring Compressor with Universal multi-purpose jaws (See below)
- New concept safety cage for safely compressing coil springs
- Cage minimizes risk of injury and improves safety
- Cage can be either bench or wall mounted



**OFFER €695.00**  
**SAVE €347.20**  
LIST PRICE €1042.20

**SP 08390500**

## Coil Spring Adaptors Kit

- Spacer Block for use with asymmetric / tapered springs
- Extensions (pair) for use with extra long strut assemblies

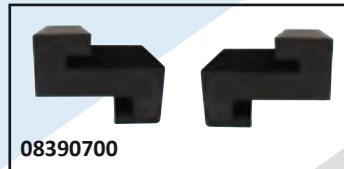

08390700

**OFFER €189.95**  
**SAVE €25.38**  
LIST PRICE €215.33

**SP 08390600**

## Spacer Block Only

**€59.95**



08390600

**SP 08390700**

## Extensions Only (pair)

**€159.95**

**SP 08450000**

## Internal Coil Spring Compressor

- Safe Working Load 2500Kg (25000N)
- Specially designed for vehicles fitted with front or rear wishbone suspension
- Designed to fit applications where the access hole in the lower wishbone is as small as 30mm diameter
- Unique Torque Safety Key extends functionality and adds safety
- Supplied with two pairs of specialist jaws up to 120mm spring diameter
- Full applications list included in kit



**OFFER €599.95**  
**SAVE €179.00**  
LIST PRICE €778.95

**SP 08400000**

## Heavy Duty Coil Spring Compressor c/w Universal Multi-Purpose Jaws

- Safe Working Load 2250Kg (22500N)
- Supplied with 1 x pair of Universal MULTIPURPOSE Jaws
  - Patented innovative shape of jaw design fits most types & sizes of springs
  - Protective high-tech inserts in jaws for added safety
  - Jaws diameter: 80 – 200mm covers 90% of applications
- Built-in protective accessory for vice-clamping
- Large user-friendly adjusting handle for fast jaw positioning
- Overload shear-pin for safe operator use
- Range of specialist jaw options available
- TUV approved
- Supplied with full Instructions and Vehicle Applications



**OFFER €599.95**  
**SAVE €179.00**  
LIST PRICE €778.95

**sp 01800000**

## Screw Extractor Set

- For removal of broken studs - 6mm - 12mm diameter
- Broken stud is drilled and an extractor is used to remove the remains of the stud
- Includes 5 x drill bits 10 x drill guides 5 x extractor assemblies



**OFFER €119.95**  
**SAVE €48.80**  
LIST PRICE €168.75

**sp 01820000**

## Straight Fluted Extractor Set

- As per 01800000 (left) - 5 x extractors only



**OFFER €89.95**  
**SAVE €38.30**  
LIST PRICE €128.25

**sp 67000600**

## Pick-Up Tool (Magnetic)

- Magnetic telescopic extension
- 135 - 480mm extended length



**OFFER €8.50**  
**SAVE €1.63**  
LIST PRICE €10.13

**sp 03280000**



## Tyre Tread Depth Gauge

- MOT Approved gauge with pocket clip
- Measures 0 - 26mm in 1mm increments
- Includes 1.6mm depth measurement for MOT regulations



**OFFER €6.95**  
**SAVE €1.83**  
LIST PRICE €8.78

**sp 05920000**



## Corrosion Assessment Tool

- Designed by the VI for checking bodywork and structural corrosion
- Approved by the VI for MOT Inspections



**OFFER €11.95**  
**SAVE €6.28**  
LIST PRICE €18.23

**sp 02810000**

## Cylinder Honing Tool (50 - 180mm)

- Flexible drive shaft, for use with air or electric drills
- Supplied with a set of medium grade 220 grit stones
- Suitable for use on large bore engine cylinders from 50 - 180mm



**OFFER €49.95**  
**SAVE €10.80**  
LIST PRICE €60.75

**sp 08245000**

## Windscreen Wiper Arm Remover

- Unique 4- way design allows for 4 different jaw widths to be selected
- Reversible and interchangeable legs
- Removable centrepiece for wider applications coverage
- Capacity from 19 - 36mm



**OFFER €59.95**  
**SAVE €20.38**  
LIST PRICE €80.33

**sp 02760000**

## Air Blow Gun

- Fingertip control provides infinitely variable airflow
- 100mm high velocity cranked nozzle
- 1/4" BSP thread connection



**OFFER €19.95**  
**SAVE €8.40**  
LIST PRICE €28.35

## Valve Grinding Sticks

Wooden handled valve sticks for grinding and lapping valves

Part No.	Description	Size	Offer Price
66090200	Large - Single Ended	32mm x 224mm	€1.95
66090300	Medium - Single-Ended	22mm x 224mm	€1.95
66090400	Small - Single-Ended	19mm x 224mm	€1.95
66090500	Small / Medium - Double-Ended	19 / 22mm x 224mm	€1.95



## SP LCSH806

**NEW**

### Lee Cooper Classic Cargo Short - Black

- Classic cargo style short with triple needle stitching for extra strength
- Modern style fit for maximum comfort and freedom of movement
- Two pleated side leg pockets
- Two deep pockets to front and back
- Gripper waistband tape on inner waist
- 65% polyester / 35% cotton twill



Available in waist sizes:  
30", 32", 34", 36", 38", 40", 42"

**€24.95**

## SP LCSH807

**NEW**

### Lee Cooper Holster Pocket Short - Black

- Classic cargo style short including additional holster pockets to front
- Modern style fit for maximum comfort and freedom of movement
- Triple stitching for extra strength
- Two pleated side leg pockets
- Two deep pockets to front and back
- Gripper waistband tape on inner waist
- 65% polyester / 35% cotton twill



Available in waist sizes:  
30", 32", 34", 36", 38", 40", 42"

**€36.95**

## SP LCSWT113

**NEW**

### Lee Cooper Panelled Hooded Sweatshirt - Black

- Features adjustable drawstring to hood and contrast woven fabric panelling to the shoulder area and elbow panels
- Includes large front panelled pocket and additional chest pocket for valuables
- Lycra re-inforced cuffs and waistband
- Reinforced elbow panels in abrasion resistant woven fabric
- 80% cotton / 20% polyester brushed fleece fabric



**€39.95**

Available in sizes:  
M, L, XL, XXL

## SP LCTS003

### Lee Cooper Technical Polo Shirt - Black

- Sportswear design, fit & styling
- Contrasting red placket and grey side panels with pockets
- 100% polyester pique fabric

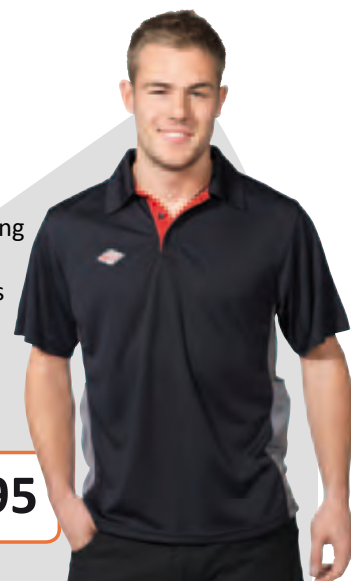

Available in sizes:  
M, L, XL, XXL, XXXL

**€24.95**

## SP LCPNT213

### Lee Cooper Heavy Duty 'Two Colour' Cargo Work Trousers - Black / Red Trim

- Multi-Tool Pockets & Combat Thigh Pocket
- Front & Rear Bellowed Pockets
- Mobile Phone Pocket
- Knee Pad Pockets (N.B. Kneepads must be ordered separately - Ref: LCKP)
- Zip Fly



Available in waist sizes:  
32", 34", 36", 38", 40", 42"

Available in leg lengths:  
Regular (32") Long (34")

**€39.95**

## SP LCPNT205

### Lee Cooper Cargo Work Trousers - Black

- 2 combat thigh pockets
- Pocket flaps with velcro
- Zip fly
- Belt loops
- 65% polyester / 35% cotton twill



**€29.95**

Available in waist sizes:  
32", 34", 36", 38", 40", 42"

Available in leg lengths:  
Short (30") Regular (32")  
Long (34")

## SP LCVST702

**€44.95**

### Lee Cooper - Reversible Body Warmer - Black

- Reversible Gilet style body warmer
- Padded Polyester quilting on one side
- Pill resistant fleece on reverse
- Two zip pockets on front
- Drawcord on hem



Available in sizes:  
M, L, XL, XXL

## 9412

€119.95

### 12 Pc. Combination Ratcheting Wrench Set

- 8, 9, 10, 11, 12, 13, 14, 15, 16, 17, 18, 19mm



Also available individually:

Part No / Size	Price	Part No / Size	Price
9108 - 8mm	€8.95	9114 - 14mm	€13.95
9109 - 9mm	€8.95	9115 - 15mm	€14.95
9110 - 10mm	€9.95	9116 - 16mm	€15.95
9111 - 11mm	€9.95	9117 - 17mm	€16.95
9112 - 12mm	€11.95	9118 - 18mm	€17.95
9113 - 13mm	€12.95	9119 - 19mm	€18.95

## 9413

### 4 Pc. Combination Ratcheting Wrench Set

- 21, 22, 24, 25mm

Also available individually:

Part No / Size	Price
9121 - 21mm	€21.95
9122 - 22mm	€22.95
9124 - 24mm	€24.95
9125 - 25mm	€25.95



€89.95

## 9520

€87.75

### 10 Pc. Combination Stubby Ratcheting Wrench Set

- 10, 11, 12, 13, 14, 15, 16, 17, 18, 19mm

Also available individually:

Part No / Size	Price
9510 - 10mm	€8.51
9511 - 11mm	€9.22
9512 - 12mm	€9.92
9513 - 13mm	€10.64
9514 - 14mm	€11.34
9515 - 15mm	€12.06
9516 - 16mm	€12.76
9517 - 17mm	€13.47
9518 - 18mm	€14.89
9519 - 19mm	€15.59



## 9620

### 12 Pc. Reversible Combination Ratcheting Wrench Set

- 8, 9, 10, 11, 12, 13, 14, 15, 16, 17, 18, 19mm

Also available individually:

Part No / Size	Price
9608 - 8mm	€9.95
9609 - 9mm	€10.95
9610 - 10mm	€11.95
9611 - 11mm	€12.95
9612 - 12mm	€13.95
9613 - 13mm	€13.95
9614 - 14mm	€14.95
9615 - 15mm	€15.95
9616 - 16mm	€16.95
9617 - 17mm	€17.95
9618 - 18mm	€18.95
9619 - 19mm	€19.95

## 9901

### 12 Pc. Combination Flexible Ratcheting Wrench Set

- 8, 9, 10, 11, 12, 13, 14, 15, 16, 17, 18, 19mm

Also available individually:

Part No / Size	Price
9908 - 8mm	€14.18
9909 - 9mm	€14.89
9910 - 10mm	€15.59
9911 - 11mm	€16.31
9912 - 12mm	€17.01
9913 - 13mm	€17.73
9914 - 14mm	€18.43
9915 - 15mm	€19.14
9916 - 16mm	€19.85
9917 - 17mm	€20.56
9918 - 18mm	€21.26
9919 - 19mm	€21.98



€188.93



€134.93



**80051**

### 12 Pc. Combination Screwdriver Set

- Slotted & Phillips
- 1 1/2", 4", 3x6", 8" Slotted
- 0, 2x1, 2x2, 3 Phillips

€89.95

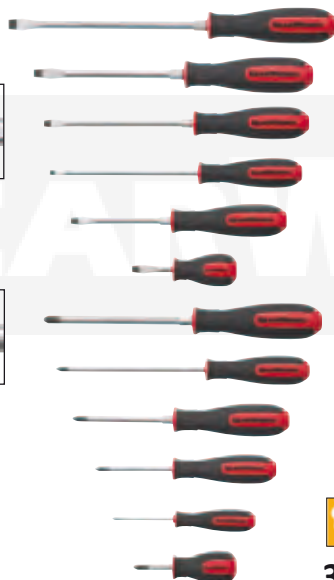

**80053**

### 5 Pc. Slotted Dual Material Screwdriver Set

- 1/8" x 3"
- 1/4" x 4"
- 1/4" x 6"
- 5/16" x 6"
- 3/8" x 8"

€47.95

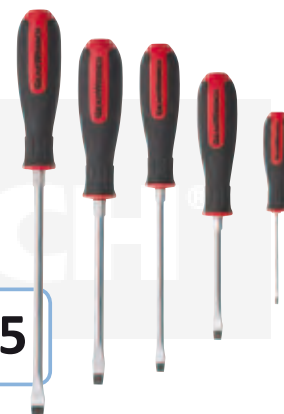

**80054**

### 7 Pc. Torx® Screwdriver Set

- T10, T15, T20, T25, T27, T30, T40

€49.95



**80064**

### 3 Pc. Long Torx® Dual Material Screwdriver Set

- T-15 / T-20 / T-25 Screwdriver 18"

€37.50

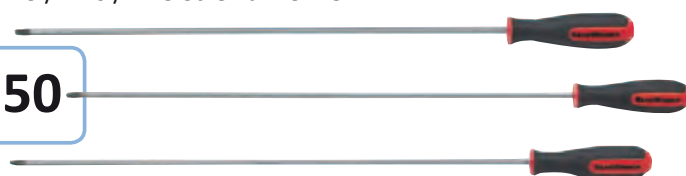

**80059**

### 4 Pc. Long Screwdriver Set

- 10", 12", 16" Slotted
- 16" size 2 Phillips

€49.95

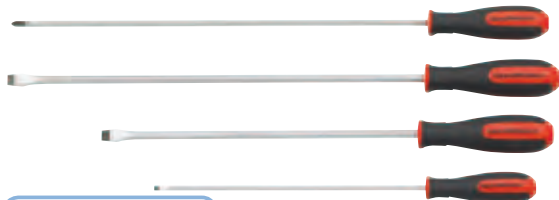

**82881**

### Folding Utility Knife - 3"

- 3" Locking blade with serrated edge
- Standard Utility blade
- Dual material body

€15.95



Storage Pouch included



€29.95



**86990**

### Mechanics Gloves - Large

- Made from Spandex and Synthetic leather
- Padded Palm Grip
- Velcro Wrist Strap
- Colour - Black / Size: Large

**80057**

### 12 Pc. Combination Mini Screwdriver Set

- Phillips #00, #0, #1
- Slotted 1.5, 2.0, 2.5mm
- Torx® T5, T6, T7, T8, T9, T10

€49.95



**8940**

### 40 Pc. Ratcheting Screwdriver Set

- Standard Stubby, T-Handle & GearDriver Handles
- 2 x Standard shafts
- 2 x Magnetic shafts
- 2 x Flex shafts
- 30 Pc. Bit Set

€79.95



# WORKSHOP EQUIPMENT

**SP 38360000**

## Universal Engine & Gearbox Support

- Designed to support the engine or gearbox when the engine bracket has been removed e.g. - when replacing timing belts, drive belts, water pumps etc
- Removes the need for using cranes, transmission jacks etc
- Universal tool designed for all makes of vehicle
- No need for costly model specific brackets
- The unit is suspended from the chassis via the support hooks, the engine / gearbox is supported by the support pad and is counter-balanced against the underside of the vehicle by the support arms
- Fully adjustable in all dimensions
  - Extension: Min 630mm / Max 960mm
  - Support Plate Adjustment: 190mm

**€319.95**



**SP 18580000**

## Hydraulic Injector Puller System

- A NEW concept for the removal of stubborn injectors
- Provides controlled force to aid the removal of seized injectors where there is insufficient access for traditional slide hammers
- Uses a multi-position frame, with adjustable legs of different lengths and a selection of mounting adaptors to allow alignment of the tool with the injectors on a wide variety of modern diesel engines
- The combination of variable leg lengths and selection of the appropriate adaptor for the cylinder head, allows the tool to be correctly positioned on most cylinder heads
- Supplied with injector adaptors for most modern injector types – M14 | M16 | M17 | M20 | M25 | M27
- 10 tonnes Hydraulic Hollow Cylinder provides the force – use with standard hydraulic pump (not supplied)



To watch a video of the Hydraulic Injector Puller, scan the QR Code



**€1195.00**

**SP 08770000**

## Universal Press Support Block

- Universal Support for use with a workshop press
- Three point contact guarantees a perfect, safe support
- Easily press bearings on a wide variety of suspension arms

Features:

- Adjustable height anvil bolts
- Swivel element for added versatility
- Safety Alignment brackets for security on press

**€389.95**



Distributor Stamp:

Sykes-Pickavant Ltd, Unit 4 Cannel Road, Burntwood Business Park, Burntwood, Staffs, WS7 3FU. United Kingdom

Tel: +44 (0) 1543 679900 Fax: +44 (0) 1543 679901

e-mail: [sales@sykes-pickavant.com](mailto:sales@sykes-pickavant.com) [www.sykes-pickavant.com](http://www.sykes-pickavant.com)

ALL PRICES QUOTED EXCLUDE VAT & ARE SUBJECT TO AVAILABILITY - E&OE - PRICES VALID UNTIL 30TH SEPTEMBER 2012 - REF: SPQ312EURO  
COPYRIGHT 2012 - SYKES-PICKAVANT LTD. ALL RIGHTS RESERVED.